

Compact ICS 7.0 System Coordinator Guide

Norstar and Meridian are trademarks of Nortel Networks
© Copyright Nortel Networks 2005

Table of Contents

Getting started with Norstar 15

- Using this guide 15
- Understanding programming 15
- Before you start 16
- What you'll need to do programming 17
- Using Buttons 17
- Using the buttons under the display 20
- The programming overlay 20**
- A map for working in programming 22
 - Programming map (page 1) 23
- Starting and ending a session 25
- Ending a session 26

Frequently used programming operations 27

- Changing the time and date on the display 27
- Adding or changing a system speed dial 29
 - Program a name for a speed dial 31
- Changing the name of a telephone 32
- Changing the name of a line 34
- Making changes to Call Forward No Answer 35
- Making changes to Call Forward on Busy 37
- Making Changes to Do Not Disturb on Busy 38
- What would you like to do next? 40

Answering calls 41

- Answering incoming calls with Hunt Groups 41
- Answering an incoming call 41
 - Line buttons 42
 - What line indicators mean 42
 - Rings you may hear 43
- Sorting calls by distinctive ring patterns 44

- Answering calls at a prime telephone 44
- Expanding telephone button capacity 45
 - Using a KIM as a central answer position 46
- Release button 50
- Hearing aid compatibility 50
- Viewing information about a call on the display 50
 - Using Call Information for a particular call 51
 - Displaying Call Information before or after answering 52
 - Displaying Call Information for a call on hold 52
 - Making Call Display information appear automatically at a telephone 52
 - Changing what information is shown first about a call 53
- Picking up a call ringing at another telephone 53
 - Answering any ringing telephone using Directed Pickup 54
 - Answering any ringing telephone using Group Pickup 54
 - Changing a pickup group for a set 55
 - Answering a call using Trunk Answer 56
 - Answer DNs and Answer keys 57
- Creating a Conference Call 58
 - Disconnecting one party 59
 - Independently holding two calls 59
 - Putting a conference on hold 60
 - Splitting a conference 60
 - Removing yourself from a conference 61
- Listening to a call as a group 62
 - Canceling Group Listening 62
- Using handsfree/mute 62
 - Answering calls without lifting the handset 63
 - Making calls without lifting the handset 63
 - Muting handsfree 64
 - Changing a regular call to handsfree 64
 - Changing a handsfree to a regular call 64
 - Using handsfree 65
 - Changing handsfree for a telephone 66
 - Changing handsfree answerback for a telephone 67

-
- Turning Privacy on or off for a call 68
 - Creating a conference by releasing privacy 68
 - Making a call private 68
 - Checking call length using Call Duration Timer 69
 - Disconnecting by accident 69
-

Making calls 71

- Choosing a line using a line button 73
 - Line pools 73
 - Using a line pool to make a call 74
 - Programming a memory button with a line pool feature code 74
 - Making calls from an ISDN terminal 75
 - Dialing calls with a second dial tone (Profile 2, only) 75
 - Changing how you dial your calls 75
 - Using Standard Dial 76
 - Using Automatic Dial 76
 - Using Pre-dial 77
 - When the dialed internal number is busy 77
 - Priority Call 77
 - Using Ring Again 79
-

Auto Attendant 81

- System Answer 81
 - Custom Call Routing (CCR) 82
 - CCR groups 82
 - Direct extension dialing 83
 - Customizing System Answer and CCR 83
 - Turning System Answer on or off 84
 - Turning CCR on or off 85
 - Choosing the attendant telephone 85
 - Changing the language for System Answer and CCR 86
 - Setting ring delay before System Answer takes a call 87
 - Setting the ring delay before CCR greeting answers 87
 - Adding/removing telephones from CCR groups 88
-

- Using the pre-recorded greetings 89
 - Using customized greetings for System Answer and CCR 89
 - Time available for customized greetings 91
 - Recording customized greetings for System Answer and CCR greetings 92
 - Programming or changing CCR destinations 94
 - Testing your custom System Answer and CCR 94
-

Time savers for making calls 95

- Storing a number on a memory button for Autodial 95
 - Using intercom as the line for Autodial 96
 - Using Last Number Redial 97
 - Preventing a telephone from using Last Number Redial 98
 - Using Speed Dial 99
 - Changing and adding System Speed Dials 99
 - Adding or changing a User Speed Dial 99
 - Making a speed dial call 101
 - Using Saved Number Redial 101
 - Saving a number 101
 - Dialing a saved number 101
 - Preventing a telephone from using Saved Number Redial 102
-

Handling many calls at once 103

- Using Hold 103
 - Retrieving a held call 103
 - Listening on hold 104
 - Holding a call exclusively 104
 - Using Call Queuing 105
 - System-wide call appearance (SWCA) codes 105
-

Transferring calls 107

- Using the transfer feature 107
 - Transferring a call 107
 - Transferring external calls 108
 - Canceling a transfer 108

-
- Using Camp-on 110
 - Parking a call 111
 - Retrieving a parked call 111
 - Using Call Park 112
 - Using Callback 113

Forwarding your calls 115

- Forwarding your calls within the system 115
 - Canceling Call Forward 115
 - Using Call Forward at your telephone 116
 - Overriding Call Forward 116
 - Changing the automatic Call Forward settings 116
 - Changing Forward no answer 117
 - Changing the delay before a call is forwarded 117
 - Forward on busy 117
 - DND on Busy 118
 - Call Forward and Voice Mail 119
- Line Redirection 119
 - Turning on Line Redirection 120
 - Canceling Line Redirection 120
 - Allowing a telephone to redirect calls 121
 - Turning the redirect ring for a telephone on or off 121
 - How Line Redirection is different from Call Forward 123
 - Using Line Redirection 123

Communicating in the office 125

- Paging 125
 - Making a page announcement 125
 - Activating and deactivating the ability to page 126
 - Creating page zones 126
 - Using Page with external paging equipment 128
- Sending messages using the display 128
 - Sending a message 128
 - Canceling a message you have sent 129
 - Viewing your messages 129
 - Replying to a message 130

- Replying to a message using an analog telephone 130
 - Removing items from your message list 131
 - Removing items from your message list using an analog telephone 131
 - Viewing messages you sent 132
 - Using Voice Call 133
 - Making a Voice Call 133
 - Answering a Voice Call without touching your telephone 134
 - Preventing Voice Calls to your telephone using Voice Call Deny 134
-

Tracking your incoming calls 137

- Using Call Log 137
 - Call Log options 138
 - Logging a call manually 139
 - Deleting old log items (autobumping) 139
 - Viewing your Call Log 139
 - Viewing a Call Log item 140
 - Erasing log items 140
 - Making a call using Call Log 140
 - Creating a password to your Call Log 141
 - Changing your Call Log password 141
 - Deleting an assigned password 141
 - Using Voice mail 143
-

Customizing your telephone 145

- Finding out what a button does using Button Inquiry 145
 - Changing the set display contrast 146
 - Changing the language on the display 146
 - Programming a feature code onto a memory button 147
 - Programming feature buttons 147
 - Erasing a feature button 147
 - Labeling your set 149
 - Applying button labelling 149
 - Digital phones 149
 - Default button assignments 150
-

- 7316E button defaults 150
- 7316 button defaults 152
- 7208 button defaults 154
- 7100 button defaults 154
- Moving line buttons 156
- Changing the type of ring 157
- Adjusting the Ring volume 157
- Hiding the message or calls indication 158
- Restoring the messages and calls indication 158

User Preferences 159

- Using User Preferences 159
 - Changing button programming 160
 - Changing a User Speed Dial 161
 - Changing Call Log options 161
 - Changing how calls are dialed 161
 - Changing the language used on the display 162
 - Making the display lighter or darker 162
 - Changing the ring on the telephone 162

Programming Hunt Groups 165

- Adding or removing members from a group 166
- Moving members of a group 167
- Assigning or unassigning lines to a group 168
- Setting the distribution mode 169
- Setting the hunt delay 170
- Programming busy line setting 170
- Programming the queue time-out 171
- Programming the overflow set 171
- Setting the name 172
- Allowing/disallowing an auxiliary ringer 172
- Assigning a distinctive ring pattern to a Hunt Group 173
- Using Silent Monitor 174
 - Feature notes 176

Using the Hospitality features 179

- Hospitality passwords 179
 - Desk pswd 179
 - Cond pswd 180
- Room/desk information 180
 - Programming room information 181
 - Using the room/set programming 182
- Programming the alarm feature 184
 - Using the Administration set to control alarms 185
 - Using the alarm 186
 - Canceling an alarm 186
 - Turning off an alarm 187

Telephone features 189

- Installing Digital phones 189
 - Mounting a digital phone on the wall 190
- Naming a telephone or a line 192
- Moving telephones 192
- Stopping calls from ringing at your telephone: Do Not Disturb (DND) 193
 - Stopping calls 193
 - Refusing to answer a call 193
 - Canceling Do Not Disturb 193
 - Using Do Not Disturb 193
- Using Background Music 194
 - Turning Background Music off 194
- Using the device attached to the internal analog terminal adapter 195
- Using a data communication device with the I-ATA 200
 - Turning off tones that can interfere with data transmissions 200
 - Programming answering machines or modems to answer calls automatically 201
 - Using the I-ATA with modems and fax machines 201
 - Troubleshooting the device attached to the I-ATA 201

ISDN 203

- ISDN BRI 203
 - Line access from an ISDN terminal 204
- ISDN BRI features 204
 - Network Name Display for BRI 204
 - Name and number blocking for BRI 205
- Service provider features 205
 - Call Forward 205
 - Canceling Call Forward 205
 - Calling the number your calls are forwarded to 206
 - Automatic Call Back 206
 - Automatic Recall 206
 - MCID (profile 2) 207
 - Network Call Diversion (profile 2) 207
- ISDN BRI terminals 208
- ISDN applications 208

Using System features 211

- Using alternate or scheduled services 211
 - Preventing certain calls from being made 211
 - Making additional telephones ring 211
 - Changing the lines used by outgoing calls 211
 - Turning Services on and off 212
 - An example of how to turn on a Service manually 213
 - Turning Services on and off using feature codes 213
 - Viewing the active Services from a two-line display telephone 214
 - Viewing the active Services from a one-line display telephone 215
- Using passwords 217
 - Using a Basic password 217
 - Changing passwords 218
 - Clearing a Call Log password 218
 - Hospitality passwords 219
 - Silent Monitor password 219
- Using special telephones 220
 - Direct-dial 220

- Changing the direct-dial telephone assignments 220
- Hotline 221
- Bypassing a Hotline 221
- Making a telephone a hotline telephone 221
- Control telephone 222
- SM Supervisor 222
- Using Set lock 223
 - Changing Set Lock programming for a telephone 223
- Using an auxiliary ringer 224
 - Setting the auxiliary ringer for a telephone 224
- Using Host System dialing signals 224
 - Link 224
 - Preventing a telephone from using Link 225
 - Pause 225
 - Long Tones 226
 - Programmed Release 226
 - Run/Stop 227
 - Wait for Dial Tone 227
 - Using tone dialing for a call 228
- Using your Norstar system from an external location 228
 - Controlling access to your Norstar system 229
 - Direct inward system access (DISA) 229
 - Class of Service (COS) 229
 - Maintaining security 230
 - Accessing Norstar remotely over the public network 230
 - Tones 231
 - Using Class of Service (COS) passwords 231

General System features 233

- Disconnect supervision 233
- Hunt Groups 233
- Internal numbers 233
- Line assignment 234
- Target line 234
- Line pools 235

- Overflow call routing 235
- Telephones with no line buttons 235
- Memory buttons 236
 - One-line display 236
- Prime line 237
- Private lines 237
- Volume bar 237

Troubleshooting 239

- Using the alarm telephone 239
 - Reporting and recording alarm codes 239
- Testing the telephone 239
 - Testing the telephone display 240
 - Testing the telephone buttons 240
 - Testing the speaker in the telephone handset 241
 - Testing the telephone headset 241
 - Testing the telephone speaker 241
 - Testing the power supply to a telephone 242

Common feature displays 243

Index 247

Getting started with Norstar

Your Norstar digital key system has many powerful features that can be customized to keep up with changes in your workplace.

Using this guide

The person who is responsible for adding or moving telephones or making changes to the system is called the system coordinator. This guide is designed to give you all the information that is required to carry out system coordinator tasks.

The first section contains step-by-step instructions about changing the time and date, deciding how many rings it takes before a call is forwarded, and other day-to-day programming. Once you understand these basic steps, you can move on to the many other features described in the second section of the guide, and refer to the first section only from time to time.

You can look at the contents page for an overview of the features that are available, or check the index for specific features or for messages displayed on your telephone.

Understanding programming

When your system is installed, your installer or customer service representative programs it to work with your telephone lines, with your private network, if you have one, and with optional equipment. They customize the system for your office. All programming is recorded in the *Norstar Programming Record*.

You may want to further customize your system. For example, you can change how some features work, or adapt the system to changes in your office. Programming allows you to change settings that probably need to be updated regularly because of staff turnover or new business contacts. You can also assign features and program buttons on individual telephones.

There are four ways to customize and maintain your Norstar system:

- Initial programming is done for you by your installer or customer service representative. It deals mostly with how the system interacts with lines, telephones, and other equipment.
- Your programming as a system coordinator changes how features work for the system, as needed. It requires a system coordinator password.
- A basic programming password is available to allow individuals other than the system coordinator to make changes without giving access to sensitive programming capabilities.
- Personal programming is available to anyone through the Feature button on their telephone. It allows individuals to change how their telephone works to suit themselves.



Before you start

Before you begin programming, plan what changes you want to make. Record the changes in the *Norstar Programming Record* so that you have the information at hand. For example, if you are going to program system speed dial numbers, fill out the page in the *Norstar Programming Record* so that you have all the numbers and codes handy once you start programming.

What you'll need to do programming

Programming is performed using a telephone that can show two lines of information on the display. Examples of telephones with two-line displays are shown on page 17.

You need a programming overlay to show which buttons to press when you are doing programming. See “The programming overlay” on page 20.

When you use a telephone for programming, it is taken out of service. This means it is unable to receive or make calls, and the call forward features do not work. Do not use the main reception telephone for programming because you may lose incoming calls.

Using Buttons

The two-line telephone you use for everyday calling is used for changes and maintenance. Examples of telephones with two-line displays are shown in the illustration below.

Digital phones used for programming and maintenance



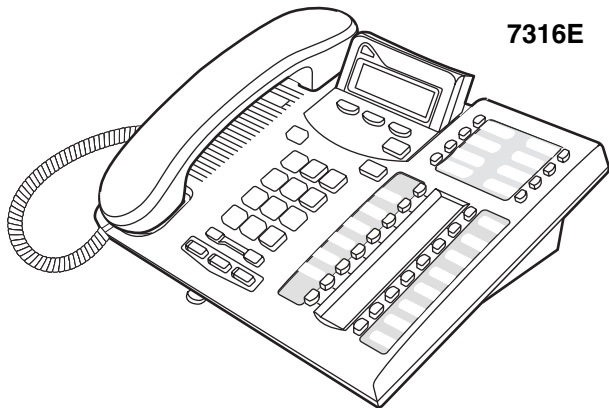



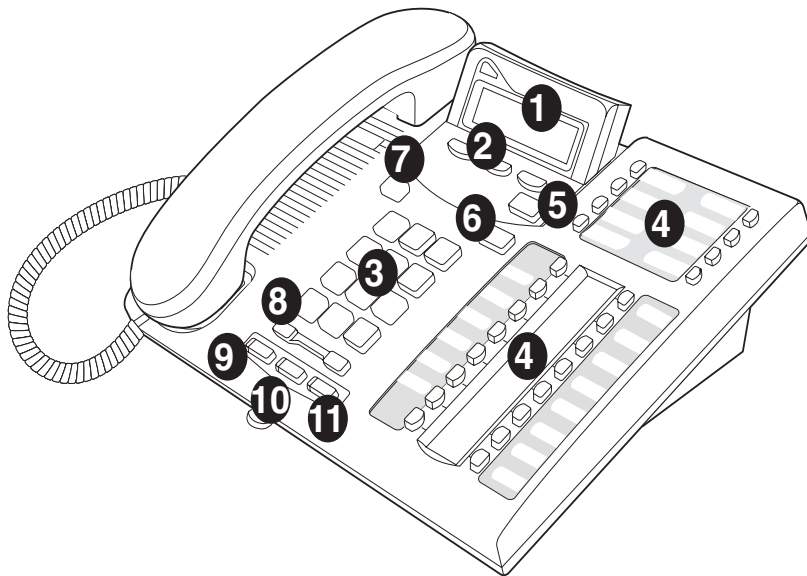

The next illustration numbers the buttons that are used for both day-to-day communication and programming on the 7316E telephone.

7316E digital phone buttons.

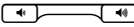

① Display	Shows instructions for everyday calling as well as for programming.
② Display buttons	Have a variety of uses. The current use is shown on the display above each button.
③ Dialpad	Used for dialing numbers when you are making calls. For programming, the dialpad is also used for entering numbers and letters
④ Memory buttons	Dial a number or feature code stored on the button.
⑤ Feature button	Allows you to enter a feature code while using or programming the telephone.
⑥ Hold button	Puts an active call on hold.
⑦ Release button	Hangs up an active call or ends programming.
⑧ Volume rocker switch	Turns the volume you hear through the handset up or down. During programming this switch is used to adjust settings, such as for the display contrast.
⑨ Mute	Mutes the transmitter in the handset.
⑩ Handsfree	Allows you to hear a caller without lifting the handset or wearing a headset. (7316E only).
⑪ Headset	Activates the headset feature.

This guide shows the icons for the 7316E digital phone buttons. Your telephone may have different labels, or the buttons in slightly different locations.

Button description	7316 and 7316E Digital phones
Feature	
Hold	 
Volume Control	
Release	

Using the buttons under the display

The three display buttons are used both for telephone features and programming, but what each button does depends on what the display shows. Some display instructions that you may see when making changes on the system are OK, CHANGE or COPY. In this guide, display button instructions are underlined.

Display buttons

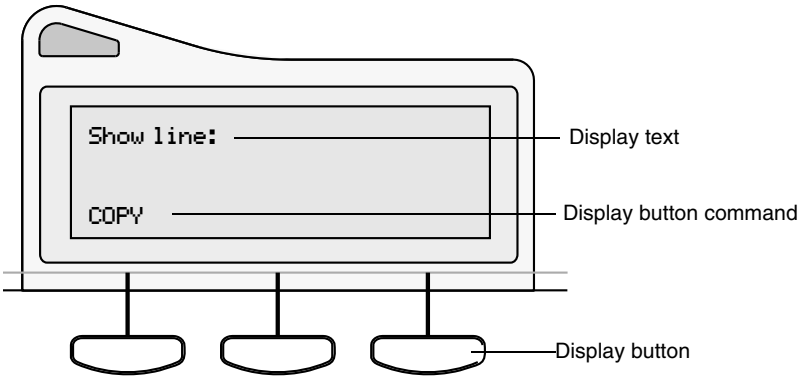

The programming overlay

When you begin programming, a group of buttons on the telephone become the buttons for moving through programming headings and settings. The programming overlay is a paper cutout that is included with each two-line digital telephone. It relabels the four buttons to name the actions you use during programming.

7316/7316E with overlay

Place overlay over keys
with indicators

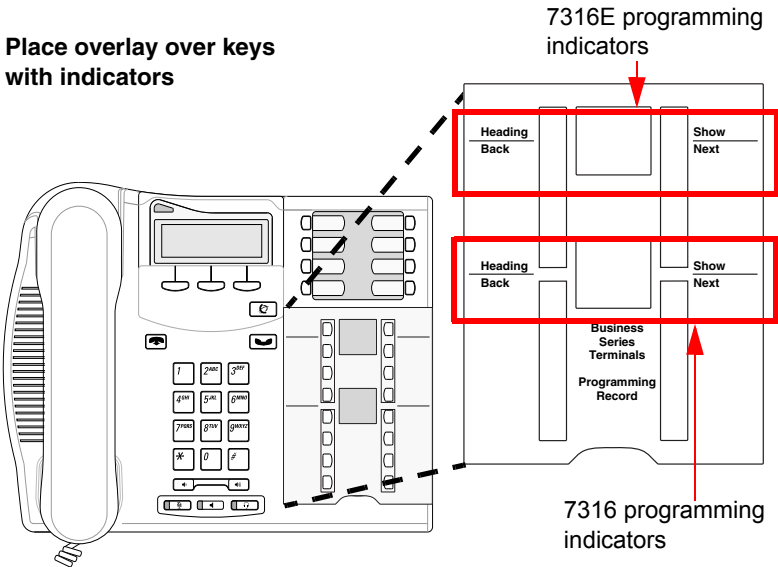

The diagram below shows how the headings are used to navigate the programming menus.

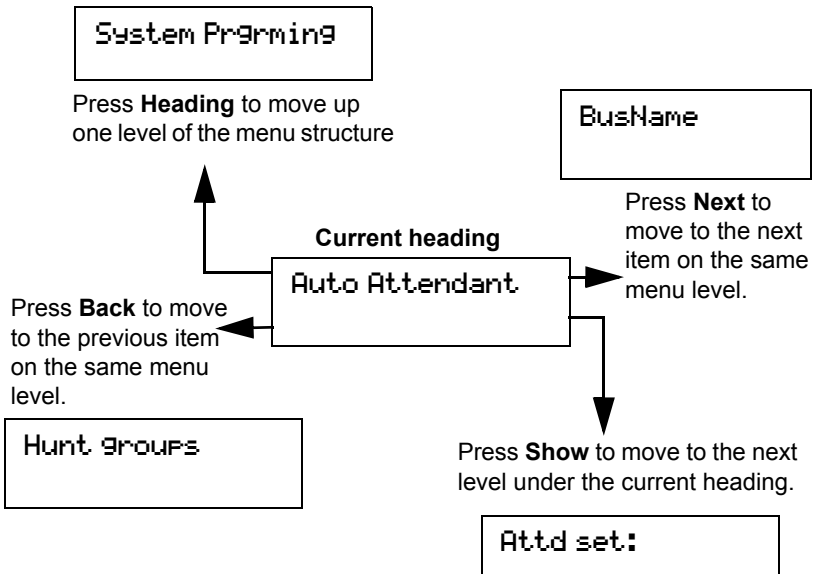

Programming buttons are active or inactive at different stages of programming. A button is active (meaning you can use that option), when the indicator next to it is lit (◀ or ▶).

A map for working in programming

The programming maps on page 23, page 24, and page 25 show the headings you see when you move through the display menu after pressing **☰ * * C O N F I G** and entering the password (the default password is **A D M I N** or **2 3 6 4 6**). The maps show you the menu choices.

A Basic password can be used with a limited number of feature codes, including *** * T I M E** and the codes for turning call services on and off. For more information, see “Using passwords” on page 217.

Terminals&Sets

Customize the many features used by telephones. You can change where a call is forwarded, give a telephone a name, or allow certain features.

Lines

Program names for each line.

Services

Turn services on or off. These are Ringing service, (often called night service) that allows additional telephones to ring, Restriction service that blocks certain kinds of calls and Routing Service that decides what lines a call uses.

Sys speed dial

Program up to 255 different telephone numbers so that people in your office can dial them with a three-digit code.

Passwords

Change the password you use for programming, or erase a Call log password.

Time&Date

Change the time, date, or both.

System Programming

Change the settings for the System Answer that handles the overflow when the attendant set is busy, and Custom Call Routing (CCR) that gives a caller a choice of where to direct their call.

Programming map (page 1)

Terminals & Sets	Show set Enter digits or press LIST.	Capabilities	Fwd no answer	Fwd to Fwd delay
			Fwd on busy	Fwd to Fwd delay
			DND on busy	Fwd to
			Handsfree	
			HF answer back	
			Pickup grp	
			Page zone	
			Paging	
			D-Dial	
			Priority call	
			Hotline	Intrn # Extrnl# Use prime line
			Aux. ringer	
			Allow redirect	
			Redirect ring	
			SM Supervisor	
			ATA settings	ATA ans timer Msg Indicate
			SWCA call group	Call 1 -- 16
		Name		
		User preferences	Model	
			Button progrming	# of buttons B01 ... BXX CLR TEL# FEATR KIM X or CAP X
			User speed dial	# of speed dialers Spd # XX
			Call log opt'ns	No one answered Unanswered by me Log all calls No autologging
			Dialing opt'ns	Standard dial Pre-dial Automatic dial
			Language	
			Display cntrst	
			Ring type	
		Restrictions	Set restrictions	Set lock (Partial, Full, None)
				Allow last no
				Allow saved no
				Allow link
		Telco features	1st Display	
			Called ID	

Programming map (page 2)

Lines	Show lines ____ Enter digits or press LIST	Name		
Services	Ringing service	Sched: Night Evening Lunch Sched 4 Sched 5 Sched 6	Off, Manual, Auto	
	Restrtn services	Sched: Night Evening Lunch Sched 4 Sched 5 Sched 6	Off, Manual, Auto	
	Routing service	Sched: Night Evening Lunch Sched 4 Sched 5 Sched 6	Off, Manual, Auto	
Sys speed dial	Speed dial # Enter digits or press LIST	add/change tel # Use prime line Display digits Name		
Passwords	Call Log pswds	Show set	Log pswd	
	Progrming pswds	Sys admin: 23646 Basic: 22742		
	Hospitality	Desk pswd: 4677 Cond pswd:None		
		SM pswd: 745368		
Time&Date	Hour			
	Minutes			
	Year			
	Month			
	Day			
System Prgrming	Hunt Group	Show Group	Member DN's	
			Line assignment	
			Mode	
			Hunt Delay	
			If Busy	
			Q Timeout	
			Overflow	
			Name	
				Show line ____ Unassigned/ Assigned
				Broadcast Sequential Rotary
		BusyTone/Queue		

Programming map (page 3)

System Prgming (continued)	Auto Attendant	Attd set	
		Language	First/Second
		System Answer	After__rings
		CCR	After__rings CCR groups
	Hospitality	Room/desk info	Show set
		Service time	Hour
			Minutes
		Alarm	Attn attempts
			Retry intrvl
			Attn duration
			Time format
			Expired alarms
			12 hr/24 hr
			Notify set
			Use tone
			Show group: Enter digits or press List
			Room #
			Adm pwd req'd

Starting and ending a session

As system coordinator, the first steps in making any change to the Norstar system are always the same.

Jan 1 12:00PM

Press .

Feature:

Press . It's the same as pressing .

Password:

RETRY

Press). Press **RETRY** to re-enter the password if it is entered wrong.

Terminals&Sets

The display shows the first of the seven headings available for administration programming.

is the password, unless the password has been changed. Check the Norstar Programming Record for the most recent password.

Ending a session

Display digits:Y

CHANGE

End of session

Press  to end the session.

After a few seconds, the time and date reappears on the display.

The system goes ahead with any changes you make to programming as soon as you move away from a setting, either by using the navigation buttons or by pressing .

You can see if the changes you made to telephone programming have taken effect by pressing the **UPDATE** display key. The display shows you how many telephones have not been updated.

Press **DNS** to see the specific extensions where programming changes have not taken effect yet. Items disappear from the list as they are updated.

Record any changes you make in the *Norstar Programming Record*. If there is a problem with the system, the installer needs to see a history of the changes you made. Remember to inform people in your office of any changes you made that affect them. For example, you may change system speed dial codes or change the number of rings before an unanswered telephone is forwarded.

Frequently used programming operations













The following sections highlight the most frequently used programming operations. To consult these or other programming operations, see either the Table of Contents or the Index.

Changing the time and date on the display

Jan 1 12:00PM





















Press .

Feature:

Press       (which is the same as      .

Password:

RETRY

Press      (    ) or      (    )

The passwords can be changed. See “Using passwords” on page 217 for more information.

Entering letters and numbers using the dialpad

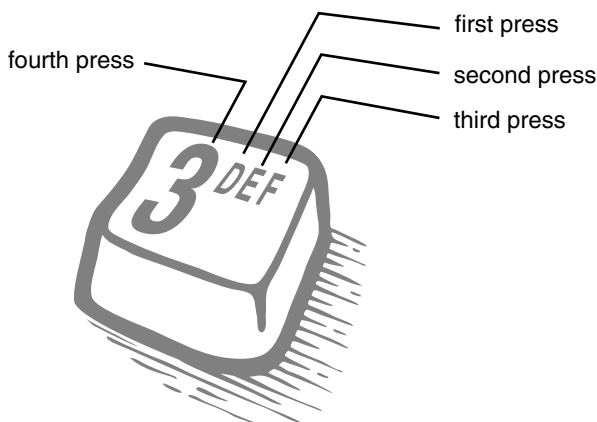

In this example, you are changing the time to 1:30 p.m.

Hour:01
NEXT CHANGE

Press CHANGE.

Hour:___
CANCL

Press the dialpad buttons to enter the hour. Use two digits for all hours. The clock on the display shows either one or two digits.

AM
OK CHANGE

The display prompts you to choose a.m. or p.m. Press CHANGE and OK to select p.m.

Hour:01
NEXT CHANGE

Press NEXT.

Minutes:00
NEXT CHANGE

Press CHANGE.

Minutes:___
CANCL

Press the dialpad buttons to enter the minutes.

If you are only changing the time and not the date, press  to end your session.

In this example, you are changing the date to July 15, 2003.

Minutes:30
NEXT CHANGE

Press NEXT.

Year:00
NEXT CHANGE

Press CHANGE.

Year:___
CANCL

Press the dialpad buttons to enter the year.

Year:03
NEXT CHANGE

Press NEXT.

Month:01
NEXT CHANGE

Press CHANGE.

Month:___
CANCL

Press the dialpad buttons to enter the month.

Use numbers for the months: 01 is January; 12 is December.

Month:07
NEXT CHANGE

Press NEXT.

Day:01
NEXT CHANGE

Press CHANGE.

Day:___
CANCL

Press the dialpad buttons to enter the day.

Day:15
CANCL

Press  to end your session.

End of session

The clock controls the schedules used for services such as ringing and routing services.

After a power failure, the clock is behind by the length of time power was lost. For example, if the power is out for two minutes, the clock is two minutes behind.

Adding or changing a system speed dial

You program a speed dial on your Norstar so that anyone in your office can dial a frequently used number using a three-digit code (001-255).



To change a speed dial that already exists, follow the same steps. The new programming overwrites the previous settings.

Begin the programming session

Jan 1 12:00PM

Press .

Feature:

Press   2 6 6 3 4 4.

Password:
RETRY

Press 2 3 6 4 6.

Choose a speed dial code

Terminals&Sets▶

Press three times.

Sys Speed Dial▶

Press .

Speed dial #:_

Press .

LIST

You can pick any system speed dial code between 001 and 255.

Speed dial #:001▶

Press .

FIND

Add or change the telephone number

001:No number

Press CHANGE.

CHANGE

001:_

Use the dialpad to program the telephone number that you want to add. The telephone number can be up to 24 digits long.

CANCL

OK

001:nnnnnnnn_

Your display shows the telephone number, and not n's as shown here. Press OK.

CANCL

BKSP

OK

Select a line for the speed dial code

001:nnnnnnnn

Press .

CLR

CHANGE

Use prime line

Press CHANGE to see your options: Use prime line, a specific line (for example Use line: 01), a line pool (for example Pool code:71), or Use routing tbl.

CHANGE

Stop pressing CHANGE when the display shows the prime line again.

Use prime line

In this example, the system selects the prime line automatically (the most common choice), to dial speed dial code 001.

CHANGE

If you assign a specific line to a system speed dial number, only telephones with an appearance of that line can use the speed dial number.

Choose what shows up on the display

Use Prime line Press .

CHANGE

Display digits:Y Your choices are Yes and No. Yes means the display shows the telephone number. Press CHANGE.

CHANGE

Display digits:N No means the display shows a name for the code.

CHANGE

Program a name for a speed dial

The system has a standard name to display, so it is not necessary for you to program one. However, if you have chosen not to display the telephone number, you may want a specific name.

Alpha tagging feature: This feature offers name display for calls coming in over lines that offer number-only display services.

If you specify a name for a speed dial, and that person calls in on an external line, the speed dial name you specify acts as the name display for the call, if the call number matches the number in the speed dial list (CLID Match). If the telephone has also been configured to display Caller ID (Caller ID set) and the name of a caller first (1st display), then the name you program for the speed dial code is the name that will display.

For example: If you create a speed dial for the courier company you use, and assign the name Courier with the following process, when that company calls you, **Courier** would appear on the display for the call.

Note: The Alpha tagging feature is only active when the system CLID service provides number-only display services.

Display digits:N Press .

CHANGE

Name:Sys Spd Di... Press .

CHANGE

...al 001 ... This is the name the display shows if you do not change it. Press CHANGE.

CHANGE

Name: _ _ _ _ _
 -->

Decide the name you want to give to the speed dial code.

Press the numeric dialpad button that has the first letter of the name until the display shows the letter you want.

Name: S _ _ _ _
 BKSP -->

Press -->.

Name: S _
 <-- BKSP -->

Use the dialpad and --> until you have the entire name.

The name can be up to 16 characters long, including spaces.
 Press # on the numeric dialpad to add spaces.

Name: SAVINGS BANK
 <-- BKSP -->

Press .

Name: SAVINGS BA...
 CLR CHANGE

Press  to end your session.

Or you can press , then to program another speed dial number.

End of session

Changing the name of a telephone

Begin the programming session

Jan 1 12:00PM

Press .

Feature:

Press * * 2 6 6 3 4 4.

Password:
 RETRY

Press 2 3 6 4 6.

Change the name of a telephone

Terminals&Sets▶ Press .

Show set:___ Enter the internal number (DN) of the telephone or
LIST voice mail extension. In this example, the DN is 21.

If the set has already been given a name, it appears after DN: on the display.

21:21▶ Press then .
FIND

Name:21 This is the name the display shows if you do not
CHANGE change it. Press CHANGE.

Decide what name you want to give to the telephone number.

Name:___ Press the telephone numeric dialpad button that
--> has the first letter of the name until the display shows the letter you want.

Name:P Press -->.
BKSP -->

Name:P___ Use the dialpad and --> until you have the entire
<-- BKSP --> name.

Name:Pat P Press to use the name you have
<-- BKSP --> entered.

The name can be up to seven characters long, including spaces.

Name:Pat P Press to end your session.
CLR CHANGE

You can press once to continue programming this telephone, or press twice to return to the Terminals and Sets heading.

End of session

Changing the name of a line

Begin the programming session

Jan 1 12:00pm

Press .

Feature:

Press .

Password:

Press .

RETRY

Change the name of a line

Terminals&Sets▶

Press .

Lines▶

Press .

Show line:____

Enter the three-digit number of the line you want to name. In this example, the line is 002.

LIST

This is the name the display shows if you do not change it.

Line002:Line002▶

Press .

FIND

Name:Line002

Press CHANGE.

CHANGE

Decide what name you want to give to the line.

Name:____

Press the telephone numeric dialpad button that has the first letter of the name, until the display shows the letter you want.

-->

Name:L

Press -->.

BKSP

-->

Name:L____

Use the dialpad and --> until you have the entire name.

<--

BKSP

-->

The name can be up to seven characters long, including spaces.

```
Name:LOCAL
<-- BKSP -->
```

Press to use the name you have entered.

```
Name:LOCAL
CLR CHANGE
```

Press to end your session.

You can press once to continue programming this line, or press twice to return to the Lines heading.

```
End of session
```

Making changes to Call Forward No Answer

Begin the programming session

```
Jan 1 12:00PM
```

Press .

```
Feature:
```

Press .

```
Password:
RETRY
```

Press .

Change where a call goes when there is no answer

```
Terminals&Sets▶
```

Press .

```
Show set:___
LIST
```

Enter the internal number (DN) of the telephone or voice mail extension. In this example, the DN is 25.

If the set has been given a name, it appears on the display.

```
25:25
FIND
```

Press .

```
Capabilities▶
```

Press .

Fwd no answer▶

Press .

Fwd to:None
CHANGE

Press CHANGE and enter the internal number where you want the calls to be sent. In this example, the DN is 21.

Fwd to:21
CLR CHANGE

You can press CLR to change the destination back to None.

Change the number of times the telephone rings before it is forwarded

Fwd to:21
CLR CHANGE

Press .

Forward delay:4
CHANGE

Use the CHANGE button to choose the number of times the telephone rings before it is forwarded.

Your choices are 2, 3, 4, 6 and 10 rings.

Forward delay:3
CHANGE

Press to end your session.

You can press to continue programming capabilities for this telephone, or press four times to return to the Terminals and Sets heading.

End of session



Tip - *If the telephone is a member of a Hunt Group, the Call Forward no answer feature is overridden and the Hunt Group call continues to ring until the hunt time has expired. For more information about Hunt Groups, see “Programming Hunt Groups” on page 165.*

Making changes to Call Forward on Busy

Begin the programming session

Jan 1 12:00PM Press .

Feature: Press .

Password: Press .

RETRY

Change where a call goes when a telephone is busy

Terminals&Sets▶ Press .

Show set:____ Enter the internal number (intercom number) of the
LIST telephone extension. In this example, the DN is 25.

If the set has been given a name, it appears on the display.

25:25 Press .

FIND

Capabilities▶ Press .

Fwd no answer▶ Press .

Fwd on busy... Press .

Fwd to:None Press CHANGE and enter the internal number where
CHANGE you want the calls to be sent. In this example, the DN is 21.

You can press CLR to change the destination back to None.

Fwd to:21 Press to end your session.

CLR CHANGE

You can press to continue programming capabilities for this telephone, or press three times to return to the Terminals&Sets heading.

End of session



Tip - *If the telephone is a member of a Hunt Group, the Call Forward on busy feature is overridden and the Hunt Group call continues to ring until the hunt time has expired. For more information about Hunt Groups, see "Programming Hunt Groups" on page 165.*

Making Changes to Do Not Disturb on Busy

When you are on a call and a second call comes in, your telephone rings softly to alert you to the second call. You can turn this feature on or off for each telephone.

Begin the programming session

Jan 1 12:00PM Press .

Feature: Press .

Password: Press .

RETRY

Change Do Not Disturb on Busy

Terminals&Sets▶ Press .

Show set:___ Enter the internal number (intercom number) of the telephone extension. In this example, the DN is 25.
LIST

If the set has been given a name, it appears on the display.

25:25 Press .
FIND

Capabilities▶ Press .

Fwd no answer▶ Press twice.

DND on Busy: N Press CHANGE to turn the feature on.
CHANGE

DND on Busy: Y A second press turns it off again. Press to end
CHANGE your session.

You can press to continue programming capabilities for this telephone, or press three times to return to the Terminals and Sets heading.

End of session



Tip - *If the telephone is a member of a Hunt Group and the set activates this feature, the telephone does not receive notification of incoming Hunt Group calls while on a call. The DND on busy feature overrides the Hunt Group. For more information about Hunt Groups, see “Programming Hunt Groups” on page 165.*

For more information about Call Forward and similar settings, see “Forwarding your calls within the system” on page 115.

What would you like to do next?

Some of the most common programming tasks are listed below. For a comprehensive list of settings and instructions, see either the Table of Contents or the Index.

Redirect calls coming in on a line.

See “Turning on Line Redirection” on page 120.

Allow individuals to answer calls that are ringing at another telephone.

See “Picking up a call ringing at another telephone” on page 53.

Assign telephones to different zones for paging.

See “Paging” on page 125.

Turn the night service on and off.

See “Making additional telephones ring” on page 211.

Use a Basic password so others can take care of programming such as changing user speed dials, changing names, changing the time and date, and activating Auto Attendant features.

See “Using passwords” on page 217.

Answering calls

Answering incoming calls with Hunt Groups

Your Norstar system allows you to establish Hunt Groups in your system. Hunt Groups are a group of Norstar set DN's that can be called by a single directory number. The Hunt Groups feature ensures calls are easily routed to the appropriate people.

You can program:

- the members for a Hunt Group
- member position within a Hunt Group
- how calls are distributed
- how long a call spends looking for available members
- what happens if all members are busy

For more information about Hunt Groups see “Programming Hunt Groups” on page 165.

Answering an incoming call

There are three possible indications of an incoming call: ringing, a line button flashing, and a message on the display. You may not receive all three indications for any particular call. For example, you may have a line that has been set up not to ring at your telephone, but which is assigned to a line button and designated as Appr only. If so, you see only a flashing icon beside the line button. There are many possible combinations, depending on how your system is set up. See “Choosing a line using a line button” on page 73 for more information about the use of lines.

If you receive a priority call and your telephone has no free internal line buttons (intercom or SWCA buttons), you cannot transfer the priority call, you must accept or release it.

Line buttons

For each line assigned to your telephone, one line button is assigned to that line. Press the line button to select the line you want to answer or use to make a call. Having several line buttons allows you immediate access to more than one line.

Note: Target lines (DID) are for incoming calls only. If you press a line button assigned to a target line that does not have an incoming call, the prompts on your telephone will indicate that the line is for incoming calls only.



The model 7000 and 7100 telephones, analog telephones, and portable handsets have two intercom paths which are used instead of line buttons to answer and make calls. Each telephone can be assigned two lines. You can press  to switch between two calls; one active and one on hold.

What line indicators mean

- ▶ Flashing on and off for equal lengths of time There is an incoming call on the line.
- ▶ Flashing on and off more quickly You have placed a call on hold.
- ▶ Flashing on for longer than off Someone else has put a call on hold on that line.
- ▶ On, not flashing You are connected to the call on that line or the line is in use elsewhere.
- Off The line is free.

The **7316E display phones** display a set of icons in place of flashing arrows when it is connected to a system with version 6.1 or newer software. If you connect a 7316E to a system that is running version 6.0 or previous versions, the standard line indicators display.

The **KIM module** also displays some of these icons. Note that this piece of hardware is only supported by version 6.1 and newer software.

-  Active call The line is active and/or you are connected to this telephone.
-  Ringing A call is coming into this line.
-  Hold The call on this line is on Hold at this telephone.



Call forward

The call on this line has been forwarded.



Active button

The feature assigned to this button is active.

Flash rate indicators for 7316E and KIM icons

On, not flashing

You are connected to the call on that line or the line is in use elsewhere or the service indicated is active

Off

The line is free

Flashing on and off for equal lengths of time

Existing alert rate

Flashing on and off more quickly (twinkle)

I-hold

Flashing on for longer than off (blink)

U-hold

Rings you may hear

A double beep every 10 seconds

A call has been camped to your telephone.

A long single ring

There is an external call on the line for you.

A shorter double ring

There is an internal call on the line for you or a call is being transferred to you.

A brief single ring

A call is being redirected on one of your redirected lines. You cannot answer this call.

Three beeps descending in tone

You are receiving a priority call.

Sorting calls by distinctive ring patterns

When lines are configured on your system, they can be assigned one of four distinctive ring patterns (DRP). The default for all telephones and lines is None, which is the lowest priority.

Call ringing: When multiple calls are presented to the telephone, the call with the highest priority DRP setting will be the call that rings at the telephone.

Call answering: When multiple calls are presented to a telephone, and the user picks up the handset, the call with the highest priority DRP setting is the call that is presented.

Note: External calls always have a higher priority than internal calls.

Note: If the ring type is changed on a telephone after the DRPs are set on the line, the line DRPs are overwritten by the telephone settings. If the DRPs are set for a line after telephone programming, then the telephone ring programming is overridden by the line DRP program. If the call is to a Hunt group, and the Hunt group DRP is higher than the line DRP, the Hunt group DRP will take precedence within the Hunt group.

Note: The Digital Mobility phone does not support this feature. The handset has a number of tones that are set-based.

Answering calls at a prime telephone

Each line in a Norstar system can be assigned a prime telephone. Calls not answered at their normal destinations are transferred to the prime telephone. The prime telephone is usually the telephone assigned to the attendant. The installer or customer service representative programs a prime telephone for a line.

Displays

DND from 21

The person at telephone 21 has forwarded a call to you using Do Not Disturb.

DND transfer

The system has transferred a call to you from a telephone with Do Not Disturb turned on.

DRT Line001	Nobody answered this call so the system transferred it to you.
Line001 callback CALLBACK	Someone has camped, parked or transferred a call on line 001, but no one has answered it. Press <u>CALLBACK</u> or the line button to connect to the call.
Line001 to prime	There is no telephone that can receive a call on line 001 so the system has transferred it to you.
Line002>Line052	The call coming in on line 002 was intended for target line 052. Line 052 is busy so the call has come to you.

For other displays, see “Common feature displays” on page 243.

Expanding telephone button capacity

You can add additional memory buttons to 7316E digital phones connected to KIMs (T24 key indicator modules). If you add the modules without identifying them as enhanced central answering positions (eCAPs) in programming, the user can program the module buttons as an expanded memory button set.

However, if you want to designate one person as the central answering position for your system, you can program the 7316E+eKIM to support lines. eKIMs also support multiple target line appearances and Hunt group appearances.

For details about configuring the KIM modules, refer to the *Compact ICS 7.0 Installer Guide*.

Using a KIM as a central answer position

When you deploy a CAP consisting of a 7316E digital phone and one or more KIMs, the modules can be configured as eKIMs by your installer. If you do not need lines or hunt group appearances on the KIMs, there is no requirement for any system configuration. A KIM that only supports memory button configuration is referred to as an ordinary KIM (OKIM). You can install up to nine OKIMs on a 7316 digital phone.



TIP - *You must have version 6.1 or newer software to use KIMs.*

If you connect more than four OKIMs to a 7316E, you need to add a Supplementary Auxiliary Power Supply (SAPS).

It is best if the eCAP is the prime telephone and direct-dial telephone for the lines and telephones it serves.

7316E digital phone with added KIM

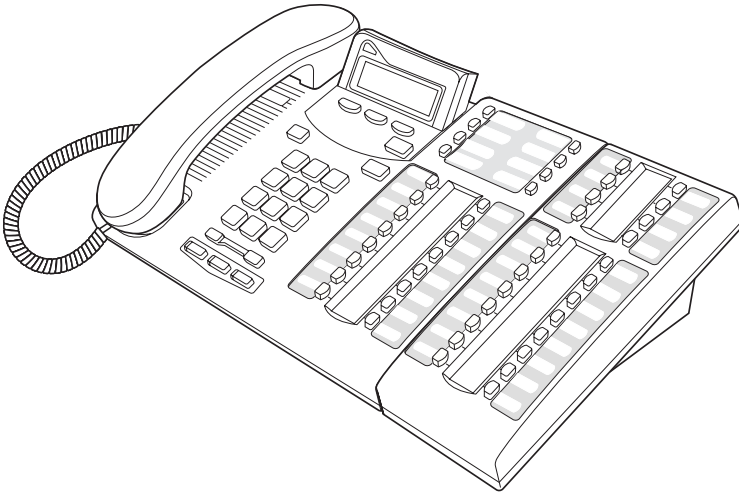

KIM memory button programming can provide:

- feature access (Refer to “Programming a feature code onto a memory button” on page 147)
- access to line pools (Refer to “Programming a memory button with a line pool feature code” on page 74)
- one-press external autodial (Refer to “Storing a number on a memory button for Autodial” on page 95)
- access to calls parked on system-wide call appearance (SWCA) buttons (Refer to “System-wide call appearance (SWCA) codes” on page 105)

An extended KIM (eKIM) provides the same functionality as the OKIM plus the ability to support lines, multiple target line appearances, and Hunt group appearances. A 7316E can support a maximum of four eKIMs. Your system can support one CAP. Note that this total includes any legacy 7324+CAPs that are configured as eCAPs.

Cold starting the KIM

If your KIM fails, or if you want to erase programming on the KIM, there are two types of cold start.



TIPS - *If you are cold starting an eKIM that has line or Hunt group assignments, the cold start will erase current programming, and insert the line appearances, starting with the top, left button. After all the line appearances are assigned to lines, the system adds target line or Hunt Group appearances. If any buttons are left, the system will populate the buttons with autodialer assignments.*

Use * to view button assignments after a cold start.

For both types of cold starts:

1. Unplug and replug the 7316E digital phone line cable.

The telephone will restart and all the icons will flash. When the telephone icons stop flashing, the KIM module icons start flashing.

2. At this point, do one of the following:

- **KIM single-module cold start**

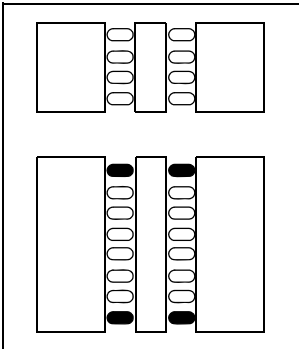

If you just want to cold start an individual module, on that module, simultaneously press the two top and two bottom buttons on the lower button set, as shown in the following diagram. The KIM displays a random pattern of icons as the KIM resets.

•**KIM**

multi-module cold start

If you want to cold start all the KIMs attached to your telephone, simultaneously press the top two buttons on the upper button set, and the bottom two buttons on the lower button set, as shown in the following diagram.

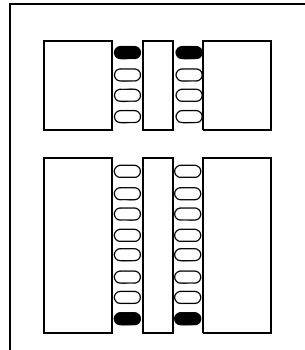

Customizing the eKIM

You can move external line appearances, target line appearances, or hunt group appearances onto the eKIM by using . See “Moving line buttons” on page 156.

Any of the buttons on the eKIM that do not support lines can be programmed to auto dial internal or external numbers. You also still can program features directly onto eKIM buttons. Refer to “Time savers for making calls” on page 95 and “Customizing your telephone” on page 145 for information about programming memory buttons.

eKIM button programming for CAP

Any line appearances and target line appearances assigned to the 7316E, which overflow to the eKIM, must be assigned by your installer. You can, however, use the Coordinator password to assign the telephone to the hunt groups for which you want to provide an appearance. Refer to “Programming Hunt Groups” on page 165 for information about programming hunt group appearances.

Designating features or autodial numbers to the eKIM buttons, can be programmed using the **Button Programing**, which is found under **User Preferences** under **Terminals&Sets**.



1. Place the programming overlay over the appropriate buttons on your two-line-display telephone.
2. Press .
3. Press (the default System Coordinator password). **Terminals&Sets** displays.
4. Press . **Show set:** displays.
5. Enter the DN number of the 7316E which is attached to the eKIM you want to program, then press **OK**.
6. Press . **Capabilities** displays.
7. Press two times until **User Preferences** displays.
8. Press . **Model** displays (7316E+<n>KIM).
9. Press . **Button Programing** displays.



10. Press the **KIM** softkey for the KIM for which you want to program buttons.
If no KIM softkeys appear, it means the KIM was not configured as a CAP in programming.
11. Press **Next** until you find the button you want to program.
12. Press **TEL#** to enter an autodial number or Hunt group DN or press **FEATR** to enter a feature code and feature programming. To make the button blank, press **CLR**.

Monitoring telephones from the CAP

The indicator icons beside the buttons on the CAP show the status of system telephones or lines that are configured on the CAP. Refer to “What line indicators mean” on page 42 icons.

Release button

Pressing  ends a call. You do not have to put the handset down.  also ends feature programming.

While you are on a call, do not press  to end a feature you are using. If you do, you disconnect the call. Use  instead.





Hearing aid compatibility

The handsets on all Norstar and BST telephones are compatible with hearing aids as defined in the FCC rules, Part 68, section 68.316. Not all hearing aids are optimized for use with a telephone.

Viewing information about a call on the display

If you subscribe to Call Display services from your local telephone company, one line of information about an external caller is displayed after you answer. Depending on the setting and the external information available, either the caller's name or telephone number is displayed.

When you transfer an external call to another Norstar user, this information is displayed on the recipient's telephone.

Call Display information becomes available between the first and second ring of an incoming call. If you answer before the Call Display information is available on your display, and you press    , you see only the line number or line name.

To use logging features with Call Display, see “Using Call Log” on page 137.

Using Call Information for a particular call



Call Information allows you to see information about incoming calls. This information is more detailed than the Call Display information you can receive automatically. For external calls, you can display the caller name, telephone number, and the line name. For an internal call, you can display the caller name and the internal number of their telephone. You can see information for ringing, answered, or held calls.

Call Information is available for calls even if they have been transferred, forwarded or rerouted in some way.

Names and numbers for external calls are displayed only if you have subscribed to Call Display services from your telephone company.



Tip - *Call Log displays the same information as Call Information, along with the date and time of the call, and the number of times the caller called.*

Once you answer a call, new calls coming in on lines configured with CLID to telephones with CLID allowed, present the prompt: **LineXXX Calling** for two rings, and then the CLID of the caller will display for three seconds (XXXXXX).

If the call is being forwarded, the CLID will also display the number from which the call was forwarded (XXXXXXXXXX).

This transient prompt will disappear if you press a programmed feature button, external autodialer, answer DN, line button, intercom button, any

dialpad button, or handsfree button. As well, an incoming Priority call or Voice call will clear the display and display the information for the Priority or Voice call.

Displaying Call Information before or after answering

To find out who is calling or to display information about your current call:

1. Press .
2. Press or VIEW to display more information about an external call.

Call Display information becomes available between the first and second ring of an incoming call. If you answer before the Call Display information is available on your display, and you press , you see only the line number or line name.

Displaying Call Information for a call on hold

1. Press . The display shows **Select a call**.
2. Select the line on hold. Information about the call is displayed.
3. Press or VIEW to display more information about an external call.



Tip - *If your telephone automatically displays Call Display information for a call, you need to press before you can press or VIEW to display more information about the call.*

Making Call Display information appear automatically at a telephone

Each telephone that rings for an external line can display Call Display information for that line. After the call is answered, Call Display information is always shown at the telephone that answered the call. Your installer or customer service representative can program telephones to have automatic Call Display.

This feature is not available to ISDN terminals.

Changing what information is shown first about a call

Depending on the services you subscribe to, Call Display information may contain up to three parts: the name of the caller, the number of the caller, or the name of the line in your Norstar system that the call is on. For each telephone, you can determine which information is displayed first.

1. Place the programming overlay over the appropriate buttons on your two-line-display telephone.
2. Press .
3. Press (the default System Coordinator password).
4. Press and enter the internal number of the telephone you want to program.
5. Press .
6. Press four times.
7. Press .
8. Choose a setting at **1stDisplay:** using the **CHANGE** button. The choices are **Name**, **Numbr** or **Line**.

You may see **Unknown name** or **Unknown number** on the display if the information is not available from your telephone company. You may see **Private name** or **Private number** on the display if the caller blocks that information.

Picking up a call ringing at another telephone

You can pick up a call ringing at another telephone using Directed Pickup or Group Pickup.

Answering any ringing telephone using Directed Pickup

You can answer any telephone that is ringing in your Norstar system.

1. Press .
2. Enter the internal number of the ringing telephone.

Call Pickup cannot be used to answer analog lines that are set to private.

To use Call Pickup (Directed Pickup), the telephone must be ringing. If, for example, the auxiliary ringer is ringing, but the call is not ringing at a telephone, the call cannot be answered using Directed Pickup. It must be answered normally at a telephone that has a flashing indicator for the call, or by using Trunk Answer. You can answer a call that is ringing because someone has transferred the call to a telephone and the call is ringing on an intercom button



Tip - *Directed pickup can retrieve calls that are ringing on an Answer DN. While you may enter the internal number of the telephone you hear ringing, it may be calls from another telephone you are answering.*

Answering any ringing telephone using Group Pickup

Your Norstar system can be divided into four pickup groups. If you are a member of a pickup group, you can pick up a call that is ringing at any telephone in your pickup group.

Press .

Group Pickup cannot be used to retrieve a camped call.

If there is more than one incoming call at a telephone in a pickup group, a call ringing on an external line is answered first followed by calls on the prime line and, finally, calls on internal lines.



Tip - A Hunt Group call ringing at a Norstar set DN that is also a member of a call pickup group can be picked up by any telephone in that call pickup group. For more information about Hunt Groups, see “Programming Hunt Groups” on page 165.

Changing a pickup group for a set

Telephones can be put into and taken out of pickup groups.

1. Place the programming overlay over the appropriate buttons on your two-line-display telephone.
2. Press * * 2 6 6 3 4 4 .
3. Press (the default System Coordinator password).
4. Press and enter the internal number of the telephone you want to program.
5. Press twice.
6. Press five times.
7. Press **CHANGE** at **Pickup grp:** to assign the telephone to pickup group 1, 2, 3, or 4, or to None.

Displays

Already joined

You are already connected to the telephone that made the call you are trying to pick up. This can happen if you are on a call to a co-worker, your co-worker dials the number of a telephone in your pickup group, and you attempt to pick up that call.

Pickup denied

There is no call that you can pick up or the call that was ringing has already been answered.

You have tried to pick up a call on someone else's private line.

Pickup:

Enter the internal number of the telephone that is ringing. (You may use an internal autodial button to do this.)

If you decide not to answer a ringing call after you have activated Directed Pickup, press .

Answering a call using Trunk Answer

Press  8 0 0.

The Trunk Answer feature allows you to answer a ringing call anywhere in the system from any telephone in the system. The line you are answering does not have to appear or ring at the telephone you are using.

Trunk Answer works only with calls that are ringing on lines for which a Ringing Service schedule is active and if Trunk Answer is enabled by your installer or customer service representative.



Tip - *If there is more than one incoming call on lines in a Ringing Service, the Trunk Answer feature picks up the external call that has been ringing the longest.*

Displays

Line denied

You have tried to pick up a call on someone else's private line.

Pickup denied

The call that is ringing is on a line that is not in a Ringing Service.

Answer DN's and Answer keys

If you have Answer DN's assigned to memory buttons with displays, you can use an Answer DN button to monitor calls on another telephone. The calls that come to the monitored telephone that provide an appearance on the Answer DN button are determined by the system-wide Anskey setting.

Answer buttons are useful for attendants who monitor incoming calls for one or several other people. For example, a secretary may have appearances for three different bosses on her answer buttons. Once a call for boss A is answered by the secretary, the appearance stops at that telephone. This allows for another, simultaneous call to come in on the same line. The same is true for boss B and boss C. When incoming call traffic becomes high, the calls can then be routed to a Hunt Group to optimize call handling. For more information about Hunt Groups, see "Programming Hunt Groups" on page 165.

Systems running MICS 7.0 and newer software can also use an Answer DN button to auto dial the telephone. The Answer DN must be idle (no indicator) for this feature to work. This feature does not prevent you from assigning a memory button as an auto dial button for the same DN.

Digital Mobility phones, and the 7000 and 7100 digital phones, can also have Answer DN's assigned. However, since these telephones do not have, or do not have enough, memory buttons with display keys, the Answer DN must be set to Ring Only. These telephones also only have two assigned intercom buttons, therefore, a maximum of two Answer DN's can be answered and active at the same time.

Answer DN's are assigned under **Terminals&Sets** under **Lines, Line Assign**. This setting assigns the DN of another telephone to one of your telephone buttons.

Answer keys are assigned under **System Programming, Feature settings**. This setting determines which calls will appear at the bottom. There are three levels: Basic, Enhanced, and Extended.

You need an Installer password to perform this programming. See the *Compact ICS 7.0 Installer Guide* for more information.

- ISDN terminals cannot be assigned Answer buttons to monitor other sets, but they can be monitored.
- You cannot make calls using Answer buttons.

- If more than one call is ringing at a telephone, the first call appears on the Answer button of the attendant. Any subsequent calls appear on intercom buttons, if they are available.





Tip - *More than one attendant may have an Answer DN button for the same telephone. This allows two or more attendants to handle calls for a busy person.*



Each telephone can handle calls for up to eight other people using a separate Answer DN button for each person.

Creating a Conference Call

You can talk to two people at once.

1. Make sure you have two calls, one active and one on hold.
2. Press  .
3. Press the appropriate button to retrieve the held call.
This is automatic on the 7000 and 7100 digital phones and the Digital Mobility phones.

You can create a conference when you are on a call.

1. Make a second call.
2. Press  .
3. Press the button where the first call is on hold to create a conference.

Only the person who established the conference can process the conference by using the procedures described in this section.



Tip - *You can create a conference by releasing privacy on a call. See “Turning Privacy on or off for a call” on page 68.*

Disconnecting one party





You can disconnect one party from a conference and continue talking to the other.

On system digital phones except for the 7000 or 7100 digital phones and Digital Mobility phones.

On the telephone you are using for system programming:

1. Press the line button of the call that you want to disconnect. The call that you want to keep is automatically put on hold.
2. Press . The call is disconnected.
3. Press the line button of the held call to speak to the remaining person.

On a 7000 or 7100 digital phone or a Digital Mobility phone:



1. Press  # , to place one caller on hold. Press /R again, to put the caller you want to keep on hold.
2. Press . The call is disconnected.
3. Press /R to speak to the remaining party.

Independently holding two calls

For all telephones except the 7000 and 7100 digital phones, and the Digital Mobility phones, you can put the two people in a conference call on hold independently so that they cannot talk to each other.

1. Press the line button of one person. The other person is automatically put on hold.
2. Press . The second person is put on hold.

You can re-establish the conference.

1. Take one call off hold.
2. Press  .
3. Take the other call off hold.

Putting a conference on hold

You can put a conference on hold, allowing the other two people to continue speaking to each other by pressing hold.

You can reconnect to the conference by pressing either of the held line buttons. For the 7000 and 7100 digital phones, press . For Digital Mobility phones, press R.

Splitting a conference

You can talk with one person while the other person is on hold.



You can activate this feature on all system digital phones except for the 7000 and 7100 phones and Digital Mobility phones.





TIP - Refer to the Nortel Networks Digital Mobility Handset 7420 User Guide for details about the handset icons. On the Digital Mobility handset, the R (Recall) button performs the function of a Hold key.

1. Press the line button of the person you want to speak to. The other person is automatically put on hold.

On the 7000 and 7100 digital phones and the Digital Mobility phones:

1. Press  # . The first party is on hold.
2. Press /R, if necessary, to switch parties.

You can re-establish the conference.

1. Press  .
2. Take the held call off hold.
This is not necessary for the 7000 and 7100 digital phones or the Digital Mobility phones.

Removing yourself from a conference

You can remove yourself from a conference, and connect the other two callers through your Norstar system.

Enter the Transfer feature code .

When you remove yourself from a conference using the Transfer feature, and both callers are from outside your system, one of the callers must have called you on a disconnect supervised line, or the call is disconnected.

Displays

3 Parties only

You are trying to add a fourth party to your conference call, or to join two conferences together. Release one call from the conference before adding another, or keep the two conferences separate.

Conf. on hold

You have put a conference call on hold.

Conference busy

You have tried to make a conference call, but your system is already handling its maximum of four conference calls.

Line001 21
TRANSFER





You are on a conference with the two lines or telephones shown. You can drop out of the conference and leave the other two parties connected (Unsupervised Conference) by pressing TRANSFER or entering the Transfer feature code.

Press held line

You have activated the Conference feature with one call active and another on hold. Press the line of the call on hold to bring that person into the conference.





For other displays, see “Common feature displays” on page 243.

Listening to a call as a group

To allow people in your office to listen in on a call using Group Listening, press    .

Continue to speak to the caller through the telephone handset. The voice of the caller broadcasts through the speaker on your telephone. The microphone on your telephone is off, so the caller does not hear people in your office.

Canceling Group Listening

Group Listening is canceled automatically when you hang up or when you press     .



Tip - *Keep the handset away from the speaker, or you may hear feedback. The higher the volume, the more the feedback. Press  to prevent feedback when hanging up.*

Using handsfree/mute

The ability to use handsfree has to be turned on or off for each telephone. The type of handsfree can be changed. See “Changing handsfree for a telephone” on page 66.

Handsfree must be set to **Std** or **Auto** in system programming for a telephone to be able to use a headset. This programming is performed by someone with the Installer password.

Note: The 7000 and 7100 digital phones, analog telephones, and Digital Mobility phones do not support handsfree, unless otherwise noted by the manufacturer. For these telephones, set Handsfree to None. The Digital Mobility phones have an independent mute key that mutes the handset microphone.

If the telephone is set to Auto, the next incoming call defaults to the voice path used by the last call. For instance, if you answered your last call using the headset button, the next call will automatically default to the headset if

you do not make any changes before answering the call. If you plug in a headset, the telephone will automatically switch the voice path to headset. This will not change the mute status of the call. You can also change the voice path by choosing either the handsfree or headset button.

7316E voice path features: The 7316E digital phone must be set to **Auto** to allow activate the handsfree, which is located under the dial pad, beside the mute and headset buttons.

Answering calls without lifting the handset

1. Press the line button for the ringing call.
This step is not necessary if you have a prime line assigned to your telephone.
2. Press the handsfree button. The internal microphone and speaker are automatically turned on.

Note: The 7316E digital phones have a handsfree button located below the dialpad. This button only works if the telephone is wired to a system running version 6.1 or newer software and the **Handsfree** setting in programming is set to **Auto**.



Tip - *Direct your voice toward the telephone. The closer you are to the telephone, the easier it is for the microphone to transmit your voice clearly to your listener.*

Handsfree is not available for the 7000 and 7100 digital phones, analog telephones and Digital Mobility phones, unless otherwise noted by the manufacturer.

Making calls without lifting the handset

1. Press the handsfree button.
If you do not have a prime line assigned to your telephone, press a line button. The internal microphone and speaker are automatically turned on.

Note: The 7316E digital phone has a handsfree button located below the dialpad. This button only works if the telephone is wired to a system running version 6.1 or newer software and the **Handsfree** setting in

programming is set to **Auto**. All other telephones have handsfree assigned to the bottom memory button (right column, on telephones with two rows of memory buttons).

2. Dial your call.
3. Speak normally.

Muting handsfree

1. Press the mute button to switch off the telephone microphone so that you can speak privately to someone in your office while you are on a handsfree call.
2. Press the mute button to turn the microphone back on again and continue your handsfree call.

Note: The 7208, 7316 and 7316E digital phones have a mute button located below the dialpad. Other telephones have mute programmed as a handsfree/mute combination on the bottom memory button (right, column on telephones that have two rows of memory buttons). Refer to the user card for the telephones for specifics about using this button.

Changing a regular call to handsfree

1. Press the handsfree button.

Note: The 7316E digital phone has a handsfree button located below the dialpad. This button only works if the telephone is wired to a system running version 6.1 or newer software. On previous version of software, the handsfree feature is assigned to the lower, right memory button.

2. Hang up the handset.

Changing a handsfree to a regular call

Lift the handset.

Using handsfree

On models with separate handsfree and mute buttons:

- The indicator next to the handsfree button is solid when you handsfree is active and turns off when the telephone is set to handset or headset.
- The indicator next to the mute button blinks when you mute the microphone and turns off when the microphone is open.

Note: Legacy Norstar telephones have only one button for both functions. In this case, when the telephone is on handsfree and the microphone is on, the light is solid. If the telephone is on handsfree and the microphone is off, the light flashes.

Wait for your caller to finish speaking before you speak. The microphone and speaker cannot both be on at once. The voice of your caller may be cut off if you both speak at the same time. Noises such as a tapping pencil could be loud enough to turn on your microphone and cut off your caller's speech.

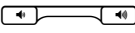
To prevent a possible echo, keep the area around your telephone free of paper and other objects that might screen your microphone. Turning down the microphone volume (press the left end of  while speaking) prevents echoes. When you change the volume level, both the microphone and speaker volume are adjusted to prevent feedback problems.

Place the telephone so that any unavoidable local noise (such as an air conditioner) is behind it. This limits the amount of disruptive background noise.



Tip - *In open-concept environments, use the handset when handsfree communication is not necessary or when you need privacy during a call. Another option is to use a headset.*

Changing handsfree for a telephone

You can program the type of handsfree used with each telephone.

1. Place the programming overlay over the appropriate buttons on your two-line-display telephone.
2. Press .
3. Press (the default System Coordinator password).
4. Press and enter the internal number of the telephone you want to program.
5. Press twice.
6. Press three times.
7. Choose a setting at **Handsfree:** using the CHANGE button.

There are three ways to set handsfree for an individual telephone:

Handsfree:None
CHANGE

Handsfree is not available to the telephone.

Handsfree:Auto
CHANGE

You can make or answer a call without having to pick up the handset or press the button labeled handsfree/mute. The internal microphone and speaker of the telephone turn on automatically when you press a line or intercom button to make or answer a call.

Handsfree:Std
CHANGE

A standard version of handsfree described “Using handsfree/mute” on page 62. Not available for 7316E digital phones.

Need Handsfree

This prompt appears if you attempt to use handsfree or headset and the telephone not been configured with Auto under **Handsfree**.

For other displays, see “Common feature displays” on page 243.

Both Auto and standard handsfree allow you to use a headset with a system digital phone.

A handsfree/mute button is automatically assigned to a legacy Norstar telephone that is programmed with handsfree and is always located in the lower right-hand corner of the numeric dialpad. For 7208 and 7316 digital

phones, this button is assigned as a handsfree-only button. The mute button is located under the dial pad.

The handsfree setting for 7316E digital phones only displays **Auto** or **None**. The handsfree button on this set is located under the dialpad. If **Handsfree** is set to **None**, the handsfree button does not function. Also, if the 7316E is attached to a system with software older than version 6.1, it acts like the 7316 telephone, and the handsfree button under the dial pad is not active.

Changing handsfree answerback for a telephone

Handsfree answerback allows you to answer a voice call without lifting the handset.

It is always turned off for an 7000 and 7100 digital phones, analog telephones, and the Digital Mobility phones.

You can turn handsfree answerback on or off for a telephone that is programmed to use handsfree.

1. Place the programming template over the appropriate buttons of the programming telephone.
2. Press * * 2 6 6 3 4 4 .
3. Press (the default System Coordinator password).
4. Press and enter the internal number of the telephone you want to program.
5. Press twice.
6. Press four times.
7. Choose a setting (Yes or No) at **HF answerback:** using the **CHANGE** button.

Turning Privacy on or off for a call





Lines in your system can be configured to have automatic privacy. If a line is not programmed with privacy, anyone with the line assigned to their telephone can join your call by pressing the line button. If a line is programmed with privacy, only one person at a time can use the line.

Privacy control cannot be used on internal or conference calls.

When another telephone joins a call, the participants on the call hear a tone, and a message appears on the telephone display. You cannot join a call without this tone being heard.

Creating a conference by releasing privacy



If a line is programmed with privacy, you can turn privacy off to allow another person with the same line to join in your conversation and form a conference. All the rules applicable to a conference apply except there is only one line in use, instead of the normal two. This means that you cannot split a conference set up using Privacy.

1. Press   .
2. Tell the other person to press the line button and join your conversation.

Only two system telephones, in addition to the external caller, can take part in this kind of conference.

Making a call private

If a line is programmed to not have privacy, you can turn privacy on for a call, preventing other people with the same line from joining your conversation.

Press   .

Checking call length using Call Duration Timer

By pressing **[☎] [7] [7]**, you can see how long you spent on your last call, or how long you have been on your present call.

Displays

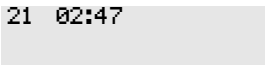

21 02:47

The display shows the last call you made, or the current call, and the total elapsed time in minutes and seconds.

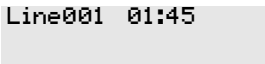

Line001 01:45

You parked your last call. The display shows the length of time the call was parked. You cannot see the length of time a call was parked unless the call is active at your telephone or has just been released by your telephone.

Disconnecting by accident

If you accidentally drop the handset back into the telephone cradle while answering a call, you can quickly retrieve the call.

Pick up the handset again or press the handsfree button within one second to be reconnected to your call.

Making calls

There are many ways to make a call, depending on the programming and the type of call, as follows:

- Pick up the handset and dial. The Norstar system supports three methods of dialing. See “Changing how you dial your calls” on page 75.
- Pick up the handset, press a line button, and dial, if the call is not on your prime line.
- Press the handsfree button and dial to talk without using the handset. See “Using handsfree/mute” on page 62.
- Press the handsfree button, press a line button, and dial to talk without the handset and if the call is not on your prime line.
- Press a line button and dial to talk without the handset and if automatic handsfree is assigned to your telephone.
- Use one of the features that make dialing easier. See “Storing a number on a memory button for Autodial” on page 95.

Displays

21 busy
PRIORITY LATER

The telephone you have called has no internal lines available. Press LATER to use the Ring Again or Message features or press PRIORITY to make a priority call.

9_
QUIT BKSP

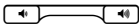
You are dialing using Pre-Dial. To erase an incorrect digit, press the left end of  or BKSP. When the number is complete, select a line or lift the handset.

95551234
 TRANSFER

This prompt remains on your display as long as you are on a call you have dialed. To transfer the call, press TRANSFER.

Already joined

Your telephone is already connected to the telephone you are trying to call. Check your active line buttons, and return to that call.

Calling 21
PRIORITY LATER

Wait for the telephone to be answered. If no one answers, press LATER to use the Ring Again (page 79) or Message (page 128) feature, or press PRIORITY to make a priority call.

Can't ring again

You cannot use Ring Again on your current call. You can only use Ring Again while you have a busy signal on an internal call or line pool request or while an internal call is ringing.

Do not disturb
PRIORITY LATER

The telephone you are calling has Do Not Disturb turned on. Press LATER to use the Ring Again or Messages features, or press PRIORITY to make a priority call.

Expensive route

You have dialed a number, but the least expensive route that the system is programmed to use is busy. Unless you release the call, it goes through on a more expensive route.

Hidden number

The last number you dialed or the number you saved for Saved Number Redial was a speed dial number that displayed a name rather than the number. The number is dialed correctly, but you cannot see it.

Line denied

You have attempted to use someone else's private line.

Line001
TRANSFER

Enter the digits of the number you want to dial.

No last number

You have not dialed an external telephone number since the last power interruption or system reset.

No line selected

Either you have no prime line or your prime line is busy. Select a line manually before dialing.

Not in service

You have entered the number of a telephone that is not in service.

On another call
LATER

The telephone you have called is on another call. Press LATER to use the Ring Again or Message features.

Restricted call

The call you are trying to make has been restricted in programming. A possible reason is time-of-day restrictions on certain calls.

Ring Again?
 YES NO EXIT

Press YES to use Ring Again. Press NO to send a message. See “Sending a message” on page 128 and “Turning on Ring Again” on page 79.

Select a line

Either you have no prime line, or the prime line is in use, or the line programmed for an autodial number, speed dial number, or Hotline is in use. Select a line and dial again.

Send message?
 YES NO

Press YES to send a message. See Messages.

For other displays, see “Common feature displays” on page 243.

Choosing a line using a line button

You have one line button for each line assigned to your telephone. Press the line button to select the line you want to answer or use to make a call. Having several line buttons allows you immediate access to more than one line.

The 7000 and 7100 digital phones and the Digital Mobility phones have two intercom paths which are used instead of line buttons to answer and make calls. These paths do not show up as display keys. Instead, the user switches between two calls by pressing  (7000/7100) or R (on the DM phone). In this situation, one call is active and one call remains on hold.

Line pools

A line pool is a group of external lines that can be shared by many telephones. You can use a line in a line pool to make an external call.

The Norstar Compact ICS can have three line pools, and a telephone can be programmed to access any number of them.

A line pool access code is a number you dial to get a line pool. The access code can be up to four digits long. You can have several different line pools for your system, each one giving you access to a different set of external lines. It is one way of sharing lines across telephones in a system.

A destination code is similar to a line pool access code, except that the line pools have been assigned to specific routing information. The destination

code is used in the same way as the line pool access code, but you may need to dial fewer following numbers if the route is set up to automatically dial part of the call number.

Your installer or customer service representative programs the line pool access codes and destination codes and gives each telephone access to the relevant line pools.

Everyone in the office should have a list of the line pool access codes and destination codes for the line pools their telephones can use.

Using a line pool to make a call

1. Press .
2. Dial a line pool access code or destination code.
3. Dial the number you are calling.

If you have a free internal line, you can make a call using a line pool without entering the feature code first.

1. Select an internal line (intercom).
2. Enter a line pool access code or destination code.
3. Dial the number you are calling.



Tip - *If no lines are available in the line pool, you can use Ring Again at the busy tone. You are notified when a line in the line pool becomes available. See “Using Ring Again” on page 79.*

Programming a memory button with a line pool feature code

When you program a button with the line pool feature code, you must enter a line pool access code after the feature code. The programmed line pool button accesses a specific line pool, not the line pool feature. See “Programming feature buttons” on page 147 for more information.

If you program a button with an indicator to access a line pool, when all the lines in a line pool are busy, the indicator for the line pool button turns on. The indicator turns off when a line becomes available.

Making calls from an ISDN terminal







ISDN terminals do not have line buttons or intercom buttons as do Norstar and BST telephones. To make an outgoing call from an ISDN terminal, access an external line by entering a line pool code or by using the ARS feature.

Dialing calls with a second dial tone (Profile 2, only)

Some call destinations require a two-stage dialing sequence that requires a second dialing tone before the local numbers are dialed. Your system administrator will indicate which destination codes or numbers require this process.

1. Dial the destination code and any initial digits specified for the call.
2. When you hear the dial tone again, complete the dialing sequence.

Changing how you dial your calls

1. Press    .
2. Press  or **NEXT** until the dialing mode you want appears.
3. Press  or **OK** to select the displayed dialing mode.

The dialing modes feature code cannot be programmed onto a memory button.

Using Standard Dial

Standard Dial allows you to make a call by selecting a line and dialing the number. If you have a prime line, it is selected automatically when you lift the handset or press the handsfree button.

You cannot use Standard Dial on a 7000 or 7100 telephone unless you pick up the handset first. If you are using either of these telephones, use the Automatic Dial or Pre-dial feature for on-hook dialing.

Digital Mobility phones only support standard dial. To dial, ensure that the handset is activated, and then dial the call number. The handset programming may allow pre-dial, but that feature would be specific to handset.

Using Automatic Dial

Automatic Dial allows you to dial a number without selecting a line. Your prime line is selected as soon as you start dialing a number.



Automatic Dial does not work if your telephone has no prime line or if your prime line is in use.

Telephones connected to an analog terminal adapter (ATA) cannot use Automatic Dial.

Using Pre-dial

Pre-dial allows you to enter a telephone number, check it, then change it before actually making the call. The call is not dialed until you select a line or line pool, or pick up the handset. You can pre-dial both external and internal numbers. You must, however, select the correct type of line (external or internal) for the type of number you have entered.



Tip - *If your telephone starts ringing while you are pre-dialing a number, you can stop the ringing by turning on Do Not Disturb (  ). This does not affect numbers you are entering.*

You cannot pre-dial a telephone number if all the lines on your telephone are busy.

When the dialed internal number is busy

Priority Call

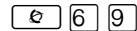

If you get a busy signal or a Do Not Disturb message when you call someone in your office, you can interrupt them. Use this feature for urgent calls only.



Tip - *Priority calls cannot be made to Hunt Group DNs. For more information about Hunt Groups, see “Programming Hunt Groups” on page 165.*

Digital Mobility phones receive priority calls as ringing calls. The existing call automatically goes on hold and the priority call becomes the active call.

Making a priority call

1. Press .
2. Wait for a connection, then speak.

A person who receives a priority call while on another call has eight seconds to accept or block the call. For information about blocking calls, see “Using Do Not Disturb” on page 193. If the person does nothing, the priority call feature puts their active call, including conference parties, on Exclusive Hold and connects your call.

Giving a telephone the ability to make priority calls

1. Place the programming template over the appropriate buttons of the programming telephone.
2. Press .
3. Press (the default System Coordinator password).
4. Press and enter the internal number of the telephone you want to program.
5. Press twice.
6. Press nine times. The display shows **Priority call:**.
7. Press **CHANGE** to choose **Y** (Yes) or **N** (No).

Displays

Call blocked

You tried to place a priority call to another system telephone. The person you called has blocked your call. Try to call later.

Please wait

The party you are calling has eight seconds to decide whether to accept or reject your priority call.

Priority denied

The telephone you are calling has already received a priority call or is unable to receive priority calls.

You can make a priority call only while your telephone displays:

21 busy
PRIORITY LATER

Calling 21
PRIORITY LATER

Do not disturb
PRIORITY LATER

On another call
PRIORITY LATER

Using Ring Again

Use Ring Again when you call someone on your Norstar system and their telephone is busy or there is no answer. Ring Again can tell you when they hang up or next use their telephone. You can use Ring Again to tell you when a busy line pool becomes available.



Tip - *The Ring Again feature cannot be used when calling a Hunt Group DN. For more information about Hunt Groups, see “Programming Hunt Groups” on page 165*

Turning on Ring Again

Press **[*] 2** before you hang up.

Using Ring Again cancels any previous Ring Again requests at your telephone.

Canceling Ring Again

Press **[*] # 2** to cancel a Ring Again request.

Displays

Can't ring again

You cannot use Ring Again on your current call. You can only use Ring Again while you have a busy signal on an internal call or line pool request, or while an internal call is ringing.

Ring Again?

YES NO EXIT

Press YES to use Ring Again. Press NO if you prefer to send a message.

Auto Attendant

The built-in Auto Attendant automatically answers and directs incoming calls, which can reduce or eliminate the workload for the person who answers incoming calls for an office. The Auto Attendant carries out three tasks: System Answer, Custom Call Routing (CCR) and direct extension dialing.



Tip - *The Auto Attendant can transfer calls to a Hunt Group. For more information about Hunt Groups, see “Programming Hunt Groups” on page 165.*

Your installer or customer service representative enables the Auto Attendant for your Compact ICS, and programs which lines are to be answered by CCR.

You may have the option of choosing to record your own greetings instead of using the pre-recorded greetings for System Answer and CCR. Consult your Customer Service Representative to determine whether or not your system has the capability to record customer greetings.

System Answer

The System Answer feature simplifies the job of answering calls by making sure all calls are answered within a set number of rings. When calls go unanswered at the telephone monitored by System Answer (called the attendant set), Norstar answers the call and plays a greeting. It then puts the call on hold until someone can retrieve it.

If the caller knows the internal number they want to reach, or is using the Norstar remote features, they can dial while the System Answer greeting is playing.

System Answer monitors all external calls that appear as a flashing line button on the attendant telephone, including Answer buttons and external calls that have been transferred. After System Answer has played the greeting, the call is put on hold at the same line indicator where it first appeared. The feature does not answer calls from internal extensions.

Custom Call Routing (CCR)

The job of answering and transferring calls can be taken over by CCR. When someone calls on lines monitored by CCR, the system answers the call and plays a greeting you have recorded. Callers using a tone dial set can then:

- direct their call by pressing a digit as instructed by your greeting (for example, “to reach our salespeople, press 4”)
- enter an internal telephone number (a fast way for regular callers to reach someone directly)
- access remote features
- reach an attendant by pressing a single digit (a way to transfer out of CCR and talk to someone)

You can use two greetings with CCR: one for when your office is open, and one for when it is closed. The business closed greeting may announce your office hours and give a digit to press to leave a message (if you have a voice mail system or answering machine), and callers can dial an internal number to reach someone who is working after hours.

If CCR forwards a call and it goes unanswered (either because the caller enters an invalid extension number or no one is there to answer the call) the call is redirected to ring at the prime telephone after the usual Callback delay. Once a caller has dialed out of the CCR greeting, he or she is not able to return and make another selection.

CCR groups

CCR allows callers to reach groups of telephones by dialing a single digit they select from the audio menu. You create the CCR groups in programming.

When a call is sent to a CCR group in which all the telephones have the same programming, the call goes to the telephone with the lowest internal number.

If the telephones in a CCR group have different programming, the call is handled by the telephone programming that takes effect first. For example, if a telephone in a group forwards after two rings, it forwards the call from

CCR before the telephones in the group that are programmed to forward after three rings.

A CCR call is forwarded by Forward on Busy, the Call Forward feature code, and Callback programming. Be sure to keep this in mind when programming the telephones in your CCR groups.

When a call that was handled by CCR rings at your telephone, call information appears automatically on the display. You must subscribe to a call display service and have the proper equipment installed in your system for this feature to work. If CCR is programmed to answer the call in less than two rings, the call information may not be captured and forwarded to the telephones in the CCR group.

Direct extension dialing

Both System Answer and CCR give the caller the opportunity to dial an internal telephone number or use remote feature access such as direct inward system access (DISA). This means callers do not have to wait to reach the person they are calling and only the person they are calling has to handle the call.

Customizing System Answer and CCR

Your installer or customer service representative turns on System Answer and CCR for your system. They assign which lines can be answered with CCR. Until this master control is turned on, the Auto Attendant features are not available.

It is recommended that the CCR not be programmed to answer lines that are answered by System Answer at the attendant telephone (usually the reception telephone).

Plan how you are going to customize System Answer and CCR before you start programming.

- Decide which telephone is to be the attendant telephone. This telephone is one where calls can be answered automatically and put on hold.
- For pre-recorded greetings, decide which language is to be used to greet callers. If you want two languages, decide which is heard first.

- Write down the greetings or scripts that you want to record as the company greeting and business closed greeting. Refer to examples in “Recording customized greetings for System Answer and CCR greetings” on page 92.
- Organize your telephones into groups and decide what number a caller is to use to reach each group. Using the groups and numbers you have created, write down the greeting or “script” to be heard as the CCR.
- Decide how many times a call rings before System Answer and CCR answer. Be sure it does not conflict with voice mail or other auto attendant applications you may be using. If CCR lines ring at the attendant set, CCR and System Answer can conflict.
- Use a programming session and feature codes to create your custom System Answer and CCR.
- Test both System Answer and CCR to make sure they are working properly.
- Make sure your installer or customer service advisor has programmed your system to use the held line reminder tone. This provides another indication that System Answer has placed a call on hold.

Turning System Answer on or off

* 8 3 1

System Answer can be turned on and off at any telephone in the system. System Answer handles only the calls that ring at the attendant telephone (attendant set).

1. Press * . The display shows the current status of System Answer.
2. Press **CHANGE** or and enter the System Coordinator password or Basic password (the default passwords are and) to turn the feature on or off.
3. Press **OK** or to confirm the change.

Because System Answer answers calls and then puts them on hold, the feature should be turned off when no one is at the telephone to retrieve the calls.



Tip - You can program the feature code for turning System Answer and CCR on or off on a memory button with an indicator at the attendant telephone. You know that the feature is turned on when the indicator is lit at the attendant set.

Turning CCR on or off

* 8 3 2

1. Press * 8 3 2 . The display shows the current status of CCR.
2. Press **CHANGE** or and enter the System Coordinator password or Basic password (the default passwords are and) to select a setting: **OFF**, **Bus. Open**, or **Bus. Closed**.
3. Press **OK** or to confirm the change.

See the section on recording greetings for a description of the Business Open and Business Closed greetings used with CCR.

Choosing the attendant telephone

Programming allows you to choose a telephone to be the attendant telephone (attendant set). External calls that go unanswered at this telephone are handled by System Answer.

1. Place the programming overlay over the appropriate buttons on your two-line-display telephone.
2. Press * * 2 6 6 3 4 4 .
3. Press (the default System Coordinator password). The display shows **Terminals&Sets▶**.
4. Press twice. The display shows **System Programming▶**.
5. Press , , and . The display shows the internal number of the current attendant telephone.
6. Press **CHANGE** and enter the internal number of the telephone you want to assign as the attendant telephone.

Changing the language for System Answer and CCR

The programmed greetings used with the auto attendant features are available in three languages. You can change which language that callers hear, or program the system to play greetings in a second language.

If you record your own greeting, that custom greeting is the one that is played regardless of the language choice.

1. Place the programming template over the appropriate buttons of the programming telephone.
2. Press .
3. Press (the default System Coordinator password). The display shows **Terminal&Sets▶**.
4. Press twice. The display shows **System Prgrming▶**.
5. Press , , and . The display shows the setting for the attendant telephone.
6. Press . The display shows **Language▶**.
7. Press . The display shows the first language used in greetings.
8. Press **CHANGE** to select a language: **English**, **French** or **Spanish**.
9. Press . The display shows the second language that callers hear. Press **CHANGE** to select a different language or **NONE**.

Setting ring delay before System Answer takes a call

1. Place the programming template over the appropriate buttons of the programming telephone.
2. Press .
3. Press (the default System Coordinator password).
4. Press twice.
5. Press , , and .
6. Press twice. The display shows **System Answer...**
7. Press .
8. Press **CHANGE** until you see the appropriate number of rings (between 1 and 12).

If the system is busy answering calls, the line rings until System Answer can retrieve the call.

Setting the ring delay before CCR greeting answers

1. Place the programming template over the appropriate buttons of the programming telephone.
2. Press .
3. Press (the default System Coordinator password).
4. Press twice.
5. Press , , and .
6. Press three times. The display shows **CCR▶**.
7. Press .
8. Press **CHANGE** until you see the appropriate number of rings (between 1 and 12).

If the system is busy answering calls, the line rings until CCR can retrieve the call.

If CCR is programmed to answer the call in less than two rings, the call information may not be captured and forwarded to telephones in the CCR group.

Adding/removing telephones from CCR groups

The greeting you create for CCR tells a caller to press a number to reach a group of telephones. You add or remove telephones from these groups (CCR groups) in programming.

1. Place the programming template over the appropriate buttons of the programming telephone.
2. Press * * 2 6 6 3 4 4 .
3. Press (the default System Coordinator password).
4. Press twice.
5. Press , , and .
6. Press three times. The display shows **CCR**.
7. Press .
8. Press . The display shows **CCR GROUPS**.
9. Press and enter the number of the group to which you want to make changes.
10. Press and enter the internal number of the telephone you want to add or remove from the group.
11. Press **CHANGE** to select the status of the telephone in the group:
Assigned, Unassigned.

You can have a total of nine CCR groups. Each group can include up to 20 telephones.

Using the pre-recorded greetings

Pre-recorded greetings are always used when the System Answer or CCR are turned on, even if you do not create personalized recordings. The pre-recorded greetings can be turned off (not erased) and/or replaced with user-recorded substitutes. If a pre-recorded greeting is turned off, all System Answer and CCR features that use that greeting are affected.

Incoming calls at the attendant telephone hear the System Answer greetings. Lines that are set up to be answered by CCR hear a different set of greetings. They are:

- All of our operators are busy.
- If you know the extension that you want, and are using a touch-tone phone, please dial it now.
- *Or*, hold the line and your call will be answered as soon as possible.
- Thank you for calling.

In the next section, these recordings appear (in italics) as part of examples of complete greetings that callers might hear. “Thank you for calling” is heard when the caller does not respond to the Business closed greeting after it has been repeated, before the system disconnects the caller.

Using customized greetings for System Answer and CCR

Norstar uses both greetings you record and pre-recorded greetings to tell callers how their call is being handled. You can make your own voice recordings for all of the greetings used in System Answer and CCR.

For customer greetings, you can create your own version or turn the greeting off completely. With system greetings, you can select the system version, create your own version, or turn the greeting off.

The following examples use greetings recorded for use at a company called Bluebird Consulting. You can use them as models for when you make your own recordings.

The pre-programmed parts of the greetings are shown in italics.

System Answer on:

You have reached Bluebird Consulting. *All of our operators are busy. If you know the extension that you want, and are using a touch tone phone, please dial it now. Or, hold the line and your call will be answered as soon as possible.*

You may choose to create your own message (shown in italics following) instead of using the pre-recorded greetings:

You have reached Bluebird Consulting. *We can't come to the phone right now. If you know the number of the person you are trying to reach, enter the number now. Or stay on the line and someone will assist you momentarily.*

CCR, Bus. open:

You have reached Bluebird Consulting. To reach one of our sales agents, press 1. To contact our accounting office, press 2. To reach Joan Smithers, press 3. To talk to an attendant, press 0. To repeat this menu, press star. *If you know the extension that you want, and are using a touch tone phone, please dial it now. Or, hold the line and your call will be answered as soon as possible.*

CCR, Bus. closed:

You have reached Bluebird Consulting. Our offices are closed. Our business hours are 8 a.m. to 5 p.m., Monday through Friday, Pacific Standard Time. *If you know the extension that you want, and are using a touch tone phone, please dial it now.*



Tip - *For better sound quality in your greetings, use the handset for recording greetings (not the handsfree microphone).*

Time available for customized greetings

You have a total of 96 seconds of recording time to allocate to all greetings. If you begin by recording a 15-second company greeting, there are 81 seconds available for the remaining greetings ($96-15=81$). The maximum length of a single recording is 32 seconds. If you exceed the maximum time for a single recording, an error message, accompanied by a tone, is given.

A greeting that is turned off is not erased. The time used by the greeting does not return to the 96-second time pool.

User-recorded greetings are stored on the feature card. The recordings are erased when the card is replaced. If the same card is removed then reinserted, the recordings are preserved. You must re-record all user-recorded greetings when upgrading to a new feature card.



System greetings are permanent and can never be erased.

FLASH memory degrades slightly each time a message is recorded. Typically, messages can be erased and written thousands of times. However, care must be taken to plan out what messages are to be recorded and how often they are to be changed in order to reduce the number of re-recordings made over a long period of time. A warning is given when the card has degraded significantly. Contact your Customer Service Representative when this warning occurs.

The pre-recorded system messages do not use any portion of the 96 seconds of total recording time. They cannot be erased, but they can be turned off or replaced with a user-recorded substitute.

Recording customized greetings for System Answer and CCR greetings

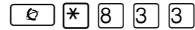

Both System Answer and CCR must be turned off to use this feature.

The customized greetings are not available to System Answer and CCR while you are recording. Callers hear only the pre-recorded greetings.

There are seven greetings to choose from, three user greetings and four pre-recorded system greetings.

You can record your own user greetings with the first three greetings choices (A, B, and C). You can also turn these greetings off.

If your system does not have the capability to allow you to record your own version of the system greetings (D, E, F, and G) you can turn on the pre-recorded system greetings or turn them off.

If your system has the capability to allow you to record your own version of the system greetings (D, E, F, and G) you can record your own system greetings, turn on the pre-recorded system greetings or turn them off.

1. Press * 8 3 3 and enter the System Coordinator password (the default password is 2 3 6 4 6).
2. If you have the capability to record your own system greetings, the display shows **Auto att grtns.**

If you do not have the capability to record your own system greetings, the display shows **Change rec time?**. Select **yes** to change the recording time or **no** to keep the recording time as is.

The display then shows **Auto att grtns.** Your choices are: **SHOW**, **EXIT**, and **NEXT**. (**NEXT** takes you to the menu for programming destinations for CCR.)

3. Press . The display shows **Grtg A mode: User**. Your choices are: **CHG**, **SHOW**, and **NEXT**. **NEXT** takes you to **Grtg B mode: User**.
4. Press **CHG** if you want to turn greeting A, B, or C off (**Off**) or if you want to record your own greeting (**User**).
For system greetings D, E, F, and G, you may select **Sys** to turn on the pre-recorded greetings, **User** to record your own version of the

greeting, or **Off** to turn them off. If your system does not have the capability to allow you to record your own version of the system greeting (D, E, F, and G), you may select **Sys** to turn on the pre-recorded greetings, or **Off** to turn them off.

A greeting that is turned off is not erased. The time used by the greeting is not returned to the 96-second time pool.

5. Press . The display shows **Greeting A: User**. Your choices are **PLAY**, **REC**, and **OK**. Press **PLAY** to play the greeting.
6. Press **REC** to record a greeting. As soon as you press **REC** the previous recording is erased. Making a recording of less than two seconds duration also erases the previous greeting.
7. Press **OK** when you have completed your recording.
8. To continue recording greetings, press **NEXT**, then **REC** to record the next greeting.
9. Press **OK** when you have completed your recording.

Example: "Our business hours are 8 a.m. to 5 p.m., Monday through Friday".

10. To continue recording greetings, press **NEXT**, then **REC** to record the next greeting, for example the caller menu.

The greeting used with the caller menu indicates the destinations you have chosen for each digit.

Example: "To reach one of our sales agents, press 1. To contact our accounting office, press 2. To reach Joan Smithers, press 3. To talk to an attendant, press 0. To repeat this menu, press star."

11. Continue recording any remaining greetings. Remember that some greetings are shared by both System Answer and CCR. Ensure that the recording is appropriate for both features.



Tip - *If you have recorded your greetings, you can press **NEXT** from the display showing **Auto att grtns** and go right into the menu for programming destinations for CCR.*

Programming or changing CCR destinations

1. Press and enter the System Coordinator password (the default password is).
2. Press NEXT until the display shows **CCR tree**. The choices are SHOW, EXIT, and PREV.
3. Press . The display shows **Dial 0:** and the current destination when the caller presses zero. Your choices are CHANGE and NEXT.
4. Press CHANGE to select the appropriate destination.

Each number from zero to nine and can direct a call to the attendant telephone or one of the nine CCR groups. The can be set up to make the system play the CCR greeting again (Repeat). If a digit is set to None, it has no destination.

Using NEXT and CHANGE, select the destinations for the remaining digits.

Testing your custom System Answer and CCR

If you have more than one external line, you can call in to hear your greetings by dialing the number used by external callers to call the attendant set or a line that is answered using CCR.

To call systems with only one external line, you must go to a telephone that is not connected to your system.

Time savers for making calls



Storing a number on a memory button for Autodial



You can program memory buttons for one-touch dialing of internal or external telephone numbers.

Buttons used for lines, answer DNIs, or handsfree cannot be used as autodial buttons.

If the power to your Norstar system is off for more than three days, autodial numbers (as well as some other system programming) may be lost from the memory.

Adding an autodial button

 * 1 or  * 2

1. Press  * 1 to program an external number or  * 2 for an internal number.
2. Choose a button and then enter the number as if you were dialing it.

When programming Autodial you can use:

- Last Number Redial
- Saved Number Redial
- destination codes (use the intercom line)
- host system signaling

Choosing a line for Autodial

To include a line selection for an external number, press the line or intercom button before you enter the number. To select a line pool, press a programmed line pool button, or press the intercom button and enter a line pool access code.

If you select a line before pressing the autodial button, the call goes out on the line you have selected instead of the line that is part of the autodialer programming.

For the 7000 and 7100 digital phones, an external autodialer can be programmed only by using a line and not a line pool.



Tip - *If you do not include a line selection in an autodial number, the call uses your prime line (if you have one).*

Digital Mobility phones do not support the auto dial feature.

Using intercom as the line for Autodial

If you enter the intercom button as the line for an external autodial number, you must include a valid line pool access code or a destination code. If line pool access codes or destination codes are changed, remember to reprogram autodial numbers.

Displays

```
987_
QUIT  BKSP  OK
```

Continue to enter digits until the number is complete. Press or **BKSP** to erase an incorrect digit. Press or **OK** when you are finished.

```
Autodial full
```

The memory allotted to autodial numbers in your Norstar system is full.

```
Button erased
```

While programming external Autodial, you erased the button by pressing or **OK** before entering any digits.

```
Enter digits
QUIT  OK
```

Enter the number you want to program (choosing the line first if necessary) exactly as you would if you were making a call.

```
Intercom #: _
QUIT
```

Enter the internal telephone number you want to program.

```
Invalid number
```

You are programming an internal autodial button and have entered a number that is not an internal number on your system. Enter a valid internal number. If the number you are entering is a destination code, use external autodial.

Press a button

QUIT

Press the memory button you want to program.

Program and HOLD

Enter the number you want to program onto the button, then press .

Program and OK

QUIT OK

Enter the number you want to program onto the button, then press  or **OK**. You may include a line or line pool selection in an autodial sequence by selecting the line before entering any digits.

Programmed

The number is stored on the button.

For other displays, see “Common feature displays” on page 243.



Using Last Number Redial



Press  to redial the last external number you dialed.

Last Number Redial records a maximum of 24 digits.



Tip - If you have a programmed Last Number Redial button, you can use Button Inquiry ( * ), then press the Last Number Redial button followed by  to check the last number before you dial it.

Preventing a telephone from using Last Number Redial

Last Number Redial can be restricted at individual telephones.

1. Place the programming template over the appropriate buttons of the programming telephone.
2. Press .
3. Press (the default System Coordinator password).
4. Press and enter the internal number of the telephone you want to program.
5. Press .
6. Press three times. The display shows **Restrictions**.
7. Press twice.
8. Press . The display shows **Allow last no:**.
9. Press **CHANGE** to choose **Y** (Yes) or **N** (No).

Displays

Hidden number

The last number you dialed was a speed dial number that displayed a name rather than the number. The number is dialed correctly, but you cannot see it.

No last number

You have not dialed an external telephone number since the last power interruption or system reset.



Tip - You can copy a number onto an autodial button using Last Number Redial.

Using Speed Dial

Norstar provides two types of speed dialing: system and user.

- System Speed Dial programming allows you to assign three-digit speed dial codes to the external numbers your co-workers call most frequently.
- User Speed Dial programming allows individuals to program their own speed dial numbers.

Speed dial numbers are subject to the same restriction filters as regularly dialed numbers. Your installer or customer service representative can program system speed dial numbers to bypass dialing restrictions.

Speed dial numbers may include host system signaling codes.

Changing and adding System Speed Dials

System Speed Dial codes are numbered from 001 to 255. The system coordinator assigns numbers to System Speed Dial codes for the entire system. See “Adding or changing a system speed dial” on page 29.





Tip - *There is no difference between using User Speed Dial and using System Speed Dial. They differ only in how you program them.*

Adding or changing a User Speed Dial



To add or change a User Speed Dial number on your telephone:



1. Press   .
2. Enter a three-digit code from 256 to 279 that you want to associate with a telephone number.
3. To include a line selection for this number, press the line or intercom button. To select a line pool, press a programmed line pool button, or press the intercom button, and enter a line pool access code or destination code.

For 7000 and 7100 digital phones, analog telephones and Digital Mobility phones, you can only enter a line pool access code or a destination code.

4. Enter the number you want to program.
5. Press  or OK.

Displays

256:9_
CANCL BKSP OK

Continue entering the number you want to program. You can change the number by pressing BKSP or  . When you are finished, press  or OK.

Enter digits
QUIT OK

Enter the telephone number you want to program exactly as you would if you were dialing it normally. When you are finished, press  or OK.

Invalid code

You have entered a code outside the code range (001-255 for system, 256-279 for user).

No number stored

There is no number stored on the speed dial code you have dialed.

Program and HOLD

If you want to program a line or line pool selection for this speed dial number, select the line or line pool. Otherwise, enter the telephone number exactly as if you were dialing it normally. When you are finished, press .

Program and OK
QUIT OK

If you want to program a line or line pool selection for this speed dial number, select the line or line pool. Otherwise, enter the telephone number you want to program exactly as if you were dialing it normally. When you are finished, press OK.

Select a line

There is no line associated with the speed dial number you are trying to use. Select a free external line or line pool and enter the speed dial feature code again.

Unknown number

The system cannot dial the number stored. Reprogram the number.

For other displays, see “Common feature displays” on page 243.

Making a speed dial call

You can quickly dial external telephone numbers that have been programmed onto speed dial codes.

1. Press **[☎] 0**.
2. Enter the appropriate three-digit speed dial code.

Using Saved Number Redial

[☎] 6 7

You can save the number of the external call you are on (provided you dialed the call) so that you can call it again later. Each telephone can save one number at a time with Saved Number Redial, not one number for each line.



Tip - You can copy a number onto an autodial button using Saved Number Redial.

Saving a number

Press **[☎] 6 7** while you are on the call.

Saved Number Redial records a maximum of 24 digits.

Dialing a saved number

Press **[☎] 6 7** when you are not on a call.

If you have a programmed Saved Number Redial button, you can use Button Inquiry (**[☎] * 0**) to check the last number before you dial it.

Preventing a telephone from using Saved Number Redial

Saved Number Redial can be restricted at individual telephones.

1. Place the programming template over the appropriate buttons of the programming telephone.
2. Press .
3. Press (the default System Coordinator password).
4. Press and enter the internal number of the telephone you want to program.
5. Press .
6. Press three times. The display shows **Restrictions**.
7. Press twice.
8. Press twice. The display shows **Allow saved no?**.
9. Press **CHANGE** to choose Y (Yes) or N (No).

Displays

Hidden number

You have saved a speed dial number that displays a name rather than the number. The number is dialed correctly, but you cannot see it.

No number saved

You have tried to save the number of an incoming call. You can only save numbers that you have dialed yourself.

Handling many calls at once

Using Hold

You can temporarily suspend a call by pressing .

When a call is on hold, an indicator flashes on all telephones that have access to the line. The call can be retrieved from any of these telephones.

On the 7000 and 7100 digital phones and the Digital Mobility phones, use the Hold feature to alternate alternates between two lines. One line is active, the other is on hold. These telephones cannot retrieve a call placed on hold by another telephone.



Tip - Answered Hunt Group calls can be placed on hold at the answering system telephone. For more information about Hunt Groups, see “Programming Hunt Groups” on page 165.

Retrieving a held call

You can connect to a call on hold by pressing the flashing line button of the held call.

On 7000 and 7100 digital phones and Digital Mobility phones, use the hold feature to toggle between to active calls.

On Digital Mobility phones, if the active call is disconnected, the call on hold will ring at the handset. If the handset moves out of radio range, external active and held calls will transfer to the prime set for that telephone, but internal calls will be dropped.

Listening on hold

If you have been put on hold, you can hang up the handset while you wait for the other person to return.

1. Press .
2. Hang up the handset.
3. Press the line button of the call. You may hear indications from the far end that you are on hold (for example, tones or music).
4. When the person you were talking to returns you hear them through your telephone speaker. Lift the handset and talk.





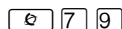

Tip - *If Automatic handsfree has been assigned to your telephone, you can use the handsfree/mute feature instead of Listen on Hold.*

This feature is not valid for the 7000 and 7100 digital phones and the Digital Mobility phones, since these telephones do not have speakers.

Holding a call exclusively



You can put a call on Exclusive Hold so that it can be retrieved only at your telephone.

Press    or  . The line appears busy on all other telephones, and the call cannot be picked up by anyone else in the office.





Displays

On hold: LINENAM

You have placed one or more calls on hold. The name of the line that has been held the longest is displayed.

Using Call Queuing













If you have more than one call ringing at your telephone, you can choose the call that has the highest priority by pressing    .









Call Queuing answers incoming external calls before callback, camped, and transferred calls.

System-wide call appearance (SWCA) codes

This feature allows a call to maintain an appearance on buttons assigned with System Wide Call Appearance (SWCA) codes to a group of users.

SWCA buttons can be assigned to memory buttons using   to assign the SWCA feature codes:     to    . See “Programming a feature code onto a memory button” on page 147 for general information about setting or changing button programming for a telephone.



Code change - *Software releases prior to MICs 7.0 used a SWCA range of     to    .* If the first code was previously assigned as a SWCA code, reprogram that button for the affected telephones.

SWCA codes can also be assigned when the telephone DN record is set up. Visible assignments are set up in button programming. Non-visible assignments are set up on the SWCA call groups setting under Capabilities. For the latter group, users use the actual SWCA codes to park and retrieve the calls. Since there is no visibility to the users without button assignments, users must employ the voice call or page feature to provide the call location to other users.

There are also three SWCA feature codes that provide flexibility for parking and accessing SWCA calls. These are especially useful for users with non-visible SWCA assignments.



Special code function note - *The special search and park codes only search among SWCA settings actually assigned to the telephone from which the code is invoked. To park and retrieve calls between groups with different sets of SWCA assignments, users still need to use the voice call or page feature to notify other users about SWCA assignments that are not specifically assigned.*

- * searches for the next available free assigned SWCA position and parks the call on that position. SWCA positions assigned to memory buttons will be searched first. If there are no available SWCA buttons, the system searches for any available assigned non-appearance SWCA positions.
- * retrieves the call that has been sitting on an assigned SWCA position the longest. The system searches only on codes assigned to the telephone.
- * retrieves the call that has most recently been parked on an assigned SWCA position. The system searches only on codes assigned to the telephone.

Refer to the *Compact ICS 7.0 Installer Guide* for information about determining how the system will assign calls to SWCA codes, and how the Hold feature will perform.



Tips - *Since SWCA buttons use the park feature, check with your system administrator to ensure that park is turned on for your system.*



A SWCA call on park that exceeds the park timeout timer is released from the SWCA button and rings again at the original telephone.

Each group telephone must either have a line appearance of the call coming in, or a free intercom button to be able to retrieve a SWCA call.

Refer to the *Norstar SWCA User Card* for detailed information about how the feature is used.





Transferring calls

Using the transfer feature

Transfer allows you to direct a call to a telephone in your Norstar system, within the Norstar network, or external to Norstar.

Transferring a call

1. Press   .
2. Call the person to whom you want to transfer the call.
3. If you want to talk to the person to whom you are transferring the call, wait for them to answer, and speak to them before proceeding.
4. When you are ready to complete the transfer, press  or JOIN.

Transfer notes:

- You cannot use Last Number Redial, Saved Number Redial, a speed dial code, Priority Call or Ring Again to dial the number for a transfer.
- Depending on how a private network call is routed, it may not always be possible for the system to return a transferred call to you if the transferred call is not answered. When transferring a call to a private network destination, stay on the line until the person to whom you are transferring the call answers.
- You cannot use the Line Pool feature code to access a line pool for a transfer. To use a line pool, use a programmed line pool button, or press the intercom button and enter a line pool access code or destination code.
- If you have an auxiliary ringer programmed to ring for calls on an external line, and you transfer a call on that line without announcing the transfer, the auxiliary ringer rings for the transferred call.

Transferring external calls

If an external call is transferred to a busy telephone, or not answered after a few rings, the call automatically rings again at the telephone from which it was transferred, and the display indicates that the telephone was busy or that no one answered.

When transferring an external call to an external number, the external call you are trying to transfer must be an incoming call on a disconnect supervised line.



While on a conference call, you can remove yourself from the conference and connect the other two callers using the Transfer feature. However, if both of the other people are from outside the system, at least one of the outside callers must have called you, and both of the outside calls must be on disconnect supervision lines.

Note: Transfer via Hold on DID lines is not supported. Once a call is answered, the line appearances on all other telephones are free immediately to take other calls. This allows a greater number of calls to be received. Use the Call Park feature or assigned SWCA buttons/codes to transfer a call. Refer to “Using Call Park” on page 112 and “System-wide call appearance (SWCA) codes” on page 105.

In certain situations, you may experience lower volume levels when transferring an external call to an external person, or when transferring two external callers from a conference call.

Canceling a transfer

You can reconnect to the person you are trying to transfer at any time before the transfer is complete.

1. Press  # 7 0 or **CANCL**.
2. If you are not reconnected to your original call, press  and then press the line button of the original call, which is now on hold.

Displays



```
21>22
CANCL  RETRY  JOIN
```

You are talking to the person you want to transfer the call to. Press RETRY if you decide to transfer the call to someone else. Press  or JOIN to transfer the call.

```
21 no reply
          CALLBACK
```

The person to whom you tried to transfer a call did not answer. Press CALLBACK or the flashing line button to reconnect to the call. On the 7000 or 7100 digital phones, lift the handset.

```
Do not disturb
CANCL  RETRY  JOIN
```

The person to whom you tried to transfer a call has Do Not Disturb active on their telephone. Press JOIN to transfer the call anyway. Press RETRY to transfer the call to someone else. Press CANCL or the flashing line button to reconnect to the call (on the 7000 and 7100 digital phones, press  #  ).

```
Invalid number
CANCL  RETRY
```

You entered an invalid internal number. Press RETRY and enter the number again.

```
Line001 hung up
```

The external caller you were transferring hung up before the transfer was complete.

```
Line001>21
CANCL  RETRY  JOIN
```

Press JOIN to transfer the call on line 001 to telephone 21. Press RETRY if, after talking to the person at extension 21, you decide to transfer the call to someone else.

```
Not in service
CANCL  RETRY
```

The telephone to which you are trying to transfer a call is out of service.

```
Restricted call
CANCL  RETRY
```

You cannot transfer the call because of telephone or line restrictions.

```
Still in transfer
CANCL  RETRY
```

Complete the transfer in progress before you access a new feature, answer another alerting call or select an outgoing line.

```
Transfer to:2_
CANCL  RETRY
```

Press RETRY if you entered the wrong internal number or if the person to whom you are transferring the call is unavailable.

Transfer denied
CANCL RETRY

Your transfer cannot be completed for one of these reasons:

- All the resources needed to perform a transfer are in use. Try again later.
- You have tried to transfer an external call to another external party. Some restrictions apply.
- You cannot transfer your conference call.

For other displays, see “Common feature displays” on page 243.

Using Camp-on

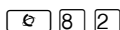

You can transfer an external call to another telephone, even if all its lines are busy.

1. Press .
2. Dial the number of the telephone you want to camp the call to.

Camped calls appear on a line button on the receiving telephone, if one is available. If there is no line button available, you receive a message on the display and hear Camp tones.

Each system telephone can handle only one camped call at a time.

Displays

21 Camp max
CALLBACK

You tried to camp a call to a telephone that already has a camped call. The call has come back to you. Press the CALLBACK button or the line button to reconnect to the call. On 7000 and 7100 digital phones, just pick up the handset.

21 DND
CALLBACK

The person to whom you redirected a call has Do Not Disturb active on the telephone. The call has come back to you. Press the CALLBACK button or the line button to reconnect to the call. On 7000 and 7100 digital phones, just pick up the handset.

Camp denied

You have tried to camp an internal call. You can only camp external calls.

Camp to:
CANCL

Dial the number of the internal telephone to which the call is sent.

Camped: 21
CALLBACK

The telephone to which you camped a call did not answer the call. The call has come back to you. Press **CALLBACK** or the line button to reconnect to the call. On 7000 and 7100 digital phones, just pick up the handset.

Line001 hung up

A call you camped has come back to you, but the caller hung up before you could reconnect.

Not in service
CALLBACK

The telephone to which you have camped a call is out of service or is being used for programming. The call has come back to you. Press **CALLBACK** or the line button to reconnect to the call. On 7000 and 7100 digital phones, just pick up the handset.

Release a call

The line that the camped call is on is in use or that line does not appear at your telephone. Release the line or release an internal line.

For other displays, see “Common feature displays” on page 243.

Parking a call

☎ 7 4

You can suspend a call so that it can be retrieved from any telephone in your system.

1. Press **☎ 7 4**.
2. Use the Page feature (**☎ 6 0**) or press **PAGE** to announce the retrieval code displayed by your telephone.

Retrieving a parked call

1. Select an internal line.
On 7000 and 7100 digital phones, pick up the handset. On Digital Mobility phones, go off-hook.
2. Dial the Call Park retrieval code.

Using Call Park

When you park a call, the system assigns one of nine codes for the retrieval of the call. These codes consist of the Call Park prefix, which may be any digit from 0 to 9, plus a two-digit call number between 01 and 09. For example, if the Call Park prefix is 4, the first parked call is assigned Call Park retrieval code 401.

The Norstar system assigns Call Park codes in sequence, from the lowest to the highest, until all the codes are used. This round-robin approach means that a greater variety of codes are used, which makes it easier for a call to reach the right person when more than one incoming call is parked.

The highest call number, which is the Call Park prefix followed by 09, is used only by telephones or devices connected to the system using an analog terminal adapter (ATA), the 7000 and 7100 digital phones and the Digital Mobility phone.

Your installer or customer service representative programs both the Call Park prefix and the delay before parked calls are returned to the originating telephone. External calls parked for longer than the programmed delay are returned to your telephone.



Tip - *Answered Hunt Group calls are parked in the same manner as other calls. For more information about Hunt Groups, see “Programming Hunt Groups” on page 165.*

Call Park can be disabled by your installer or customer service representative.



If you disable Call Park, you cannot use the system-wide call access (SWCA) feature.

Displays

Already parked

The person you were talking to has already parked your call. You cannot park the same call.

Get call first

You have attempted to use Call Park with no active call on your telephone. If the call you want to park is on hold, reconnect to it before you park it.

Invalid number

You have entered an invalid retrieval code.

No call on: 101

There was no call on the retrieval code you entered.

Park denied

You have tried to park a conference call. Split the conference and park the calls separately. The person who retrieves the calls can reconnect the conference.

Parked on: 402

PAGE EXIT

Record the code shown. Use Page () or press **PAGE** to announce the call and its retrieval code.

Parking full

All available retrieval codes are in use. Transfer the call or take a message instead.

For other displays, see “Common feature displays” on page 243.

Using Callback



When you direct a call you have answered to another telephone, the system monitors the call to make sure it is answered. If no one answers the call within a set length of time, the system directs it back to you.

Callback generates a variety of displays. Most occur after a set delay. Some occur immediately if the telephone to which you are directing a call is out of service or otherwise unavailable. These are listed with the descriptions of the specific features like Transfer or Camp-on.

Forwarding your calls

Forwarding your calls within the system

Use this feature to forward your calls within your system or network.

Press   and enter the number of the internal telephone to which you want your calls forwarded.



If you are forwarding calls outside the system, ensure that you enter the appropriate line pool access code or destination code to access the external system.

You can also use Line Redirection to forward calls outside the system. Line redirection takes precedence over Call Forward. However, line redirection is not supported on the 7000 and 7100 digital phones or the Digital Mobility phone.



TIP - 7316E digital phones display this call forwarding icon when a call has been forwarded: 

Canceling Call Forward

Press   .

Using Call Forward at your telephone

When you use  4, all calls go to the destination you select, regardless of how Forward on busy and Forward no answer are programmed.



Tip - *If your Norstar set is a member of a Hunt Group, the Call Forward all calls setting is overridden by the Hunt Group routing for Hunt Group calls. For more information about Hunt Groups, see “Programming Hunt Groups” on page 165.*

If the telephone to which you forwarded your calls does not have the same external lines as your telephone, the forwarded calls appear on intercom buttons.

If a call is forwarded, it does not ring at your telephone. However, the line indicator flashes. You can answer the call by pressing the button next to the flashing indicator. This does not cancel call forward for other calls coming in.



Tip - *If you are one of a group of people who regularly forward their calls to one another, be aware that it is possible to set up forward loops where a call is forwarded from one telephone to another in a circle, and is never answered anywhere.*

Overriding Call Forward

If you call someone who has their calls forwarded to you, your call rings at that receiving telephone even though that telephone has been set to forward calls to you.

Changing the automatic Call Forward settings

Call forwarding occurs automatically when a call is not answered or the line is busy. These automatic options are changed in programming.

For step-by-step instructions, see “Change where a call goes when there is no answer” on page 35.

Changing Forward no answer

Forward no answer redirects unanswered calls to another telephone on your Norstar system.



Tip - *If the telephone is a member of a Hunt Group, the Call Forward no answer feature is overridden and the Hunt Group call continues to ring until the hunt time has expired. For more information about Hunt Groups, see “Programming Hunt Groups” on page 165.*

For step-by-step instructions to change Forward no answer, see “Change where a call goes when there is no answer” on page 35. Line Redirection takes precedence over Forward no answer.

Changing the delay before a call is forwarded

You can assign the number of times that the incoming call rings at your telephone before the call is forwarded. To estimate the delay time in seconds, multiply the number of rings by six.

For step-by-step instructions, see “Change the number of times the telephone rings before it is forwarded” on page 36.

Forward on busy

Forward on busy redirects your calls to another telephone on your Norstar system when you are busy on a call, or when you have Do Not Disturb activated at your telephone.

For step-by-step instructions, see “Making changes to Call Forward on Busy” on page 37.

Line Redirection takes precedence over Forward on busy. Calls that are redirected by Line Redirection are not affected by any Call Forward features or Call Forward programming.

Telephones that have Forward on busy active can receive priority calls. If you are busy on a target line call, another call to that target line is redirected to the prime telephone for that target line.



Tip - *If the telephone is a member of a Hunt Group, the Call Forward on busy feature is overridden and the Hunt Group call continues to ring until the hunt time has expired. For more information about Hunt Groups, see “Programming Hunt Groups” on page 165.*

DND on Busy

When you are busy on a call and a second call comes in, your telephone rings softly to alert you to the second call. If you find this second ring distracting, you can have the system prevent a second call from disturbing you by assigning Do Not Disturb (DND) on Busy to your extension.

When DND on Busy is turned on for the telephone, internal and private network callers hear a busy tone instead of ringing when you are on the telephone. External callers are transferred to the prime set used in your system.

For step-by-step instructions, see “Making Changes to Do Not Disturb on Busy” on page 38.

If you use DND on Busy, the line indicator for an external incoming call flashes, but your telephone does not ring.

Forward on busy takes priority over DND on Busy.

If an external call uses a target line, the call is processed according to the programming of the target line. If the target line is busy, the caller may hear a busy tone or be routed to the prime set for the target line regardless of the DND on Busy programming for the telephone.



Tip - *If a telephone is a member of a Hunt Group, and the telephone activates this feature, the telephone does not receive notification of incoming Hunt Group calls while on a call. The DND on busy feature overrides the Hunt Group. For more information about Hunt Groups, see “Programming Hunt Groups” on page 165.*

Call Forward and Voice Mail

If you have a voice mail system and want it to pick up unanswered calls automatically, do one of the following:

- use the internal number of your voice mail as the destination when you program Forward no Answer and Forward on busy,
or
- make the ring delay greater than the delay used by your voice mail system, if your voice messaging system or service automatically retrieves calls.

Displays

Forward denied

There are several reasons why you may get this message. For instance, you cannot forward your calls to a telephone that has been forwarded to your telephone.

Forward>21

CANCL

Your calls are being forwarded to telephone 21.

Not in service

Two or more telephones are linked in a forwarding chain, and one of them is out of service or is being used for programming.

For other displays, see “Common feature displays” on page 243.



Line Redirection

Line Redirection allows you to send your external calls to a telephone outside the office. You may choose to redirect all your external lines or only some of them.



Line Redirection takes precedence over the Call Forward feature. If both features are active on a telephone, incoming external calls on redirected lines are routed to the specified Selective Line Redirection (SLR) external destination. Incoming internal calls are forwarded to the specified Call Forward destination.



You cannot use the Line Redirection feature on 7000 or 7100 digital phones, on Digital Mobility phones, or on an analog telephone connected to an ATA.

Turning on Line Redirection

1. Press   .
2. Select the outgoing line to be used for redirected calls.
3. Enter the number to which calls are to be redirected (the ways you can do this are listed below).
4. Select the lines to be redirected.

Enter the telephone number to which you want to redirect calls by using one of the following methods.

- Press an external autodial button.
- Enter an external telephone number (using no more than 24 digits) then press  or **OK**.
- Press  or **OK** if the line you have chosen as the outgoing line is a private network line that does not require you to dial digits.





If you use **ALL** to redirect all your lines, it is important that you wait until all the lines on your telephone light up before pressing  or **OK**. If you press  or **OK** before all the lines light up, those lines not lit are not redirected.



Tip - *The line chosen for redirecting calls on other lines can be used normally when it is not busy on a redirected call. To avoid redirection failing because the chosen line is in use, choose a line pool with several lines in it.*

The system does not check that the number you give for line redirection is a valid one. If you redirect to an invalid number, redirection fails. Using an autodial button to enter the redirection number helps avoid this possibility. An autodial button used for line redirection must be programmed to use a specific line.

Canceling Line Redirection

1. Press    .
2. Select the lines you no longer want to be redirected.

Allowing a telephone to redirect calls

You can turn the redirect calls feature on and off.

1. Place the programming template over the appropriate buttons of the programming telephone.
2. Press .
3. Press (the default System Coordinator password).
4. Press and enter the internal number of the telephone you want to program.
5. Press twice.
6. Press three times. The display shows **Allow redirect:**.
7. Press **CHANGE** to select **Y** (Yes) or **N** (No).

Turning the redirect ring for a telephone on or off

You can program a telephone to ring briefly (200 milliseconds) when a call is redirected on one of its lines.

1. Place the programming template over the appropriate buttons of the programming telephone.
2. Press .
3. Press (the default System Coordinator password).
4. Press and enter the internal number of the telephone you want to program.
5. Press twice.
6. Press twice. The display shows **Redirect ring:**.
7. Press **CHANGE** to select **Y** (Yes) or **N** (No).



Tip - *If a telephone has redirect ring enabled, it rings briefly for redirected calls on one of its lines even if another telephone set up the line redirection.*

Displays while redirecting lines

Intercom

You selected the intercom button as the facility to place the call on. Enter a line pool code or a destination code.

Line Redirection

QUIT ADD REMOVE

Press ***** or **ADD** to begin redirection. Press **#** or **REMOVE** to cancel a previous redirection.

No line to use

You have one external line on your telephone, but you need a second line to perform line redirection. Redirect your external line using a line pool as the outgoing line.

Outgoing line

You are attempting to redirect a line and the line you have chosen is the outgoing line you have selected as a destination. You cannot redirect a line to itself. Select another line.

Pool code: _

QUIT

Enter a valid line pool access code.

Redir by 21

OVERRIDE

You have attempted to redirect a line, but someone else has already redirected that line. Press ***** or **OVERRIDE** to override the previous redirection and redirect the line as you want.

Redirect denied

You can redirect calls only on individual lines.

Select line out

QUIT

Select the line to be used to redirect calls out of the system.

Select line(s)

QUIT ALL

Press the lines to be redirected. To undo a line selection, press it again. Press **ALL** to redirect all your lines.

Select line(s)

ALL OK

Continue to press the lines to be redirected. Press **OK** or **OK** when you are finished.

Unequipped line

The line you are attempting to redirect cannot be redirected because the hardware does not support redirection.

Displays while canceling redirection

```
Select line(s)
QUIT    ALL
```

Press the lines that are no longer to be redirected. The lines light up as you press them. Once you cancel redirection for a line you cannot restore it by pressing the line again. Press **ALL** to cancel redirection for all your lines. When you are finished, press  or **OK**.

```
Select line(s)
        ALL    OK
```

Continue to press the lines that are no longer to be redirected. Press  or **OK** when you are finished.

For other displays, see “Common feature displays” on page 243.

How Line Redirection is different from Call Forward



Call Forward forwards all calls that arrive at a particular telephone to another telephone within the Norstar system or over external ISDN lines.

Line Redirection redirects only calls coming in on the lines that you redirect, no matter which telephones they appear on, to a telephone outside the Norstar system. Line Redirection takes precedence over Call Forward.

Using Line Redirection

You redirect lines at a telephone, but once redirected, the lines are redirected for the entire system.

You can only redirect lines that appear at line buttons on your telephone.

You can answer the telephone if it rings while you are in the middle of programming Line Redirection, but none of the Norstar call handling features are available until the feature times out. If you need to use a Norstar feature to process the call, quit Line Redirection programming by pressing . Do not press  or you disconnect the call you are trying to process.

While you are programming Line Redirection you do not receive any indication of calls that do not actually ring at your telephone.

Be careful to avoid redirection loops. If for example, you redirect your lines to your branch office and your branch office redirects its lines to you, you can create a redirection loop. If these calls are long distance, you end up paying charges.

In certain situations, callers may experience lower volume levels when you redirect calls to an external location.

Communicating in the office

Paging

☎ 6 0

Paging allows you to make announcements over the Norstar system using the telephone speakers, or your loudspeaker system, if one is available.

The 7000 and 7100 digital phones and the Digital Mobility phones can be used to make page announcements, but these telephones cannot receive page announcements.

Making a page announcement

1. Press ☎ 6 0 .
2. Choose a page type. Page types are:
 - 1 through the telephone speakers (internal page)
 - 2 through an external speaker (external page)
 - 3 both internal and external (combined page)
3. If necessary, choose a zone.
4. Make your announcement.
5. Press 📞 .



Tip - *Instead of entering the Page feature code followed by the page type, you can enter the following shortcut codes.*

Internal ☎ 6 1 and zone (1 to 3)

External ☎ 6 2 (code 2 has no zones)

Combined ☎ 6 3 and zone (1 to 3)

Activating and deactivating the ability to page

1. Place the programming template over the appropriate buttons of the programming telephone.
2. Press * * 2 6 6 3 4 4.
3. Press (the default System Coordinator password).
4. Press and enter the internal number of the telephone you want to program.
5. Press twice.
6. Press seven times. The display shows **Paging**.
7. Press **CHANGE** to select the setting: **Y** (Yes) or **N** (No).

Creating page zones

Each telephone can be assigned to one of three zones for receiving pages.



Tip - Hunt Group DNs cannot be included in a page zone. For more information about Hunt Groups, see “Programming Hunt Groups” on page 165.

1. Place the programming template over the appropriate buttons of the programming telephone.
2. Press * * 2 6 6 3 4 4.
3. Press (the default System Coordinator password).
4. Press and enter the internal number of the telephone you want to program.
5. Press twice.
6. Press six times. The display shows **Page Zone**.
7. Press **CHANGE** to select the setting: **1**, **2**, **3**, or **None**.

You can make a telephone part of a page zone only if the telephone has paging set to **Y** (Yes).

A zone is any group of system telephones that you want to group together for paging, regardless of their location.

Your installer programs whether a tone sounds before a page begins, and the maximum number of seconds a page can last before it is automatically turned off.



Tip - *Make sure that everyone who needs to make page announcements has a list showing which telephones are in which page zones.*

Displays

Enter zone:___
ALL

Enter the desired page zone number (1- 3) or press ALL.

Invalid zone

You have entered a page zone code that is not between 1 and 3.



Page choice:
SETS SPKR BOTH

Select the type of page you want. See the list in “Making a page announcement”.

Page timeout

The time allotted for paging has expired.

Paging ALL

You are making a page. The display shows the page zone you have chosen. Press  or  when you are finished.

Paging busy

A page is already being made in the page zone you have requested.

For other displays, see “Common feature displays” on page 243.



Tip - *You can make an announcement to one person by placing a voice call to their telephone.*

Using Page with external paging equipment

When you make a page that uses external paging equipment (external page or combined page), the Long Tones feature is automatically activated for the external paging system only. This allows you to control optional equipment with the Long Tones feature.

Sending messages using the display

The Messages feature allows you to leave a message on the display of another system telephone, and indicates if you have any messages waiting.



The Messages feature uses a message waiting list to keep a record of your internal messages and your (external) voice mail messages (if you subscribe to a voice message service with visual message waiting indication).

Sending a message

You can leave a message on the display of another telephone in your Norstar system. You can send up to four messages to different telephones, including your voice message center.

If your telephone is a direct-dial telephone or a central answering position (CAP), you can send up to 30 messages.

If your reply to a message is forwarded or is answered at another telephone using the Call Pickup feature, the message remains on your telephone until you cancel it or successfully contact the telephone that sent the message.

1. Press  .
2. On a telephone with a two-line display, press **ADD**.
This step is not necessary on a telephone with a one-line display.
3. Enter the internal number of the person you want to send the message to. The display shows **Message for you**.



TIP - Only the designated direct-dial telephone for an analog telephone connected to an Analog Station Module (ASM) can send messages to analog telephones by pressing **[☎] [1]**. Depending on the programming setup, the analog telephone provides either a Stuttered Dial Tone or a Message Waiting Lamp to inform the user of messages pending.

For analog telephones connected to an ASM, the message waiting indicator remains on until the user invokes **[Link] [#] [6] [5]**. If the analog telephone has the Message Reply Enhancement feature set to Yes, the message waiting indicator is turned off automatically after the reply call is answered no matter from where the call is answered.

For more information about the Message Reply Enhancement feature, see the *Norstar Compact ICS 7.0 Installer Guide*.

Canceling a message you have sent

1. Press **[☎] [#] [1]**. The display shows **Cancel for:**.
2. Enter the internal number of the person to whom you sent the message.

Viewing your messages

[☎] [6] [5]

You can receive up to four messages from different telephones, including your voice message center. A single message from your voice message center may pertain to several voice messages.

On a telephone with a one-line display

1. Press **[☎] [6] [5]**. The display shows the first message.
2. Press **[*]** or **[#]** to move through your messages.

On a telephone with a two-line display

1. Press **MSG**. The display shows the first message you received.
2. Press **NEXT** to move through your messages.

Replying to a message

You can call the person (or your voice message center) who sent a message while you are viewing the message.

On a telephone with a one-line display:

Press **0**.

On a telephone with a two-line display:

Press **CALL**.

If you want to call your voice message center using a line other than the programmed line, exit your message list and dial the voice message center telephone number.

Replying to a message using an analog telephone

On an analog telephone connected to an Analog Station Module or an analog telephone adaptor (ATA):

Press **Link** ***** **6** **5**.

The system automatically retrieves and connects the user to the oldest message sender. (The message can originate from either the designated direct-dial telephone or the internal voice mail system.)

If the analog telephone has the Message Reply Enhancement feature set to Yes, and the sender is the designated direct-dial telephone, the message waiting indicator is turned off automatically after the reply call is answered, no matter from where the call is answered.

For analog telephones connected to an ASM, using the Message Waiting Reply feature (**Link** ***** **6** **5**), retrieves only internal messages sent to the user.

Analog telephones connected to an ASM cannot retrieve external messages by using the Message Waiting Reply feature (Link * 6 5). For external messages, users must call back the external voice mail center to retrieve their messages. When doing so, the message waiting indicator on the analog telephone is turned off automatically.



Tip - *If the designated direct-dial telephone of an analog telephone connected to an Analog Station Module (ASM) is changed, messages sent by the previous designated direct-dial telephone are kept in the incoming message list of the analog telephone until they are retrieved.*

Removing items from your message list

You can erase a message while you are viewing it in your message list. If the message is from your voice message center, this only erases the message notification at your telephone. You still need to erase the voice message at your voice message center. Refer to your voice message center documentation.

On a telephone with a one-line display:

Press .

On a telephone with a two-line display:

Press ERASE.

Removing items from your message list using an analog telephone

To remove both internal and external messages on an analog telephone, Press Link # 6 5 to invoke the Cancel Message Waiting feature.

On analog telephones connected to an ASM, the Cancel Message Waiting feature cancels the oldest message received. The system no longer provides either a Stuttered Dial Tone or a Message Waiting Lamp if there are no messages pending.

Viewing messages you sent



On a telephone with a two-line display, you can view the messages you sent.

1. Press .
2. Press SHOW to display your first sent message.
3. Press NEXT to move through your sent messages.

Displays

Cancel denied

You have entered an invalid number when attempting to cancel a message.

Cleared>LINENAM
NEXT

You have cleared an external message from your message waiting list. The message itself exists in your voice message center until you erase it there.

In use: 21

You are trying to call from your message waiting list. The line that you are trying to use is being used by the identified Norstar user.

L001:LINENAMUMsg
NEXT CALL CLEAR

You are viewing your message list. The display shows the number and name of the line that was used for your voice mail message.

Message denied

You have tried to send a message to an invalid internal number or to a telephone that is out of service.

Message list
SHOW ADD EXIT

SHOW appears only if you have outstanding messages. Press SHOW to review messages you have sent. Press ADD to send a new message.

Message to:

Enter the internal number of the telephone to which you want to send a message.

Messages & Calls
MSG CALLS

You have one or more messages and one or more new Call Logs. Press to change the first line of the display to the current time and date.

No button free

You have no line button free with which to reply to a message.

No number stored

There has been no number programmed for the voice message center. Contact your voice messaging service provider.

Start of list
NEXT

You are at the beginning of your list of messages. Press **NEXT** to move through your messages.

Their list full

You are trying to send a message to a user whose message waiting list is full.

Your list full

You have tried to send a message but your telephone list of sent messages is full. Cancel one of the messages you have sent, if possible, or wait until you have received a reply to one of those messages.

For other displays, see “Common feature displays” on page 243.

Using Voice Call





You can make an announcement or begin a conversation through the speaker of another telephone in the system.



Tip - *Hunt Groups cannot accept voice calls. Answer buttons have no appearances for voice calls, and the telephone does not ring for voice calls. For more information about Hunt Groups, see “Programming Hunt Groups” on page 165. For more information about Answer buttons, see “Answer DNs and Answer keys” on page 57.*

Making a Voice Call

Press   .

Muting Voice Call tones

When a voice call begins at your telephone, you hear a beep every 15 seconds as a reminder that the microphone is on. To stop it from beeping, pick up the handset or press the mute button.

Answering a Voice Call without touching your telephone

If handsfree answerback is assigned to your telephone, you can respond to a voice call without touching the telephone. This feature is not available to the 7000 and 7100 digital phones, analog telephones, or Digital Mobility phones. On these telephones, all voice calls are received as ringing calls.

When someone makes a voice call to you, simply start talking. The telephone microphone picks up your voice.



Tip - *Once you have answered a voice call, you can put it on hold, transfer it, or otherwise treat it as a normal call.*

Preventing Voice Calls to your telephone using Voice Call Deny

Press . Voice calls ring like regular internal calls. Your other calls proceed normally.

Canceling Voice Call Deny

Press .

Displays

Voice call

The line is open for you to speak.

Dial voice call

Dial the internal number or press the internal autodial button of the person to whom you want to speak.

Microphone muted

Your handsfree microphone is muted. Press the handsfree button or pickup your handset to respond to the voice call.

No voice call

The telephone receiving the call cannot accept voice calls for one of the following reasons:

- it is active or ringing with another call
- Call Forward is turned on
- Do Not Disturb is turned on
- Voice Call Deny is turned on
- it is not a Norstar or BST telephone.

Your call proceeds automatically as a regular ringing call.

Tracking your incoming calls

Using Call Log

Telephones can be programmed to automatically log Call Display information for calls on an external line. The line must appear on that telephone but it does not have to be a ringing line.

Alternatively, telephones can be programmed to log all calls coming into a telephone. This includes calls arriving on an Answer DN or through Call Forward. This option fills up the log space quickly, so it is recommended that you have autobumping activated on the telephone. Refer to “Deleting old log items (autobumping)” on page 139.

The system administrator determines which type of logging the system will use, and which telephones will automatically log calls or which lines on specific telephones will automatically log calls.



WARNING: If the method of call log programming is changed on a configured system, all existing logs will be deleted.

If your system is equipped with the appropriate equipment, and you have subscribed to the call information feature supplied by your service provider, you are able to capture information about incoming callers in your call log. The same feature is supplied by an ISDN service package that comes with calling line identification (CLID).

The call log record could contain the:

- sequence number in the Call Log
- name and number of the caller
- indication if the call was long distance
- indication if the call was answered (and identity of who answered it)
- time and date of the call
- number of repeated calls from the same source
- name of the line that the call came in on

Call Log can help you to

- keep track of abandoned or unanswered calls
- track patterns for your callers (for example volume of calls and geographical location of calls)
- record caller information quickly and accurately
- build a personal telephone directory from log items







The long distance indicator and the caller name and number, may not be shown in the log, depending on the Call Display services provided by your local telephone company and the local telephone company of the caller.

To use the features on the following pages, your telephone must have spaces available in its Call log. Your installer or customer service representative programs each telephone with an appropriate number of spaces.

Call Log options



You can select the type of calls to be stored in your Call Log. Choose from four Autolog options: **No one answered**, **Unanswered by me**, **Log all calls**, **No autologging**.

1. Press    . The current option displays.
2. Press  or **NEXT** to change the option.
3. Press  or **OK** to select the display option.

Logging a call manually

[☎] [8] [1] [3]

If your calls are not automatically logged, you can manually log call information when you are connected to an external call. Storing information for your current call can be helpful in many situations. For example, you may want to:

- record a caller information without using paper and pencil
- record only selected calls that you choose, as opposed to using Call Log automatically
- quickly record caller information before a caller hangs up

Press **[☎] [8] [1] [3]** to log an external call manually.

Deleting old log items (autobumping)

[☎] [8] [1] [5]

Your log has a set number of items that it can hold. When it becomes full, new calls cannot be logged. When your log is full, Autobumping automatically deletes the oldest Call Log item when a new call is logged.

Press **[☎] [8] [1] [5]** to enable autobumping.

Press **[☎] [#] [8] [1] [5]** to disable autobumping.

Viewing your Call Log



[☎] [8] [1] [2]

To view your log

1. Press **[☎] [8] [1] [2]**. The display shows the number of previously read items (old) and the number of new, unread items (new) in the log.
2. Press **[*]** or **OLD** to view old items. Press **[#]** or **NEW** to view new items.
3. Press **[0]** or **RESUME** to display the last item you viewed, the last time you viewed your Call Log.



Names and numbers for external callers are displayed only if you have subscribed to Call Display services from your local telephone company.

Viewing a Call Log item



Press   or **MORE** to view the information for a call log item.

Erasing log items

You should routinely erase log items that you have read, to make space for new items in your log.

1. Display the item you want to erase.
2. Press  or **ERASE**.
3. Press  to exit.



If you accidentally erase an item, you can retrieve it.

1. Press  or **UNDO** immediately after accidentally erasing an item.
2. Press  to exit.

Making a call using Call Log

You may find it helpful to place calls from within your Call Log. The number stored for each call may vary depending on the type of call. For example, if the call was placed from a Centrex or PBX system, the first few numbers may need to be trimmed before you can make the call. If the number you want to call is long distance, or if you want to use a line pool, you may need to add numbers.





To place a call from a call log

1. Display the log item for the call you want to place.
2. Display the associated telephone number.
3. Press   or **TRIM**, once for every digit that you want to remove.
4. Dial any extra digits required.
5. Press an external line or line pool button.
6. Lift the handset. (This is not necessary if handsfree is programmed at your telephone.) The displayed number is dialed.





Creating a password to your Call Log

You have the option of accessing your Call Log through a password.

1. Press    . The display shows **New Password:**.
2. Enter your four-digit password. The display shows **Repeat New:**.
3. Re-enter your four-digit password. The display shows **Password changed**, which confirms that your password has been assigned.





To enter Call Log using your password

1. Press     to enter Call Log. If you have programmed a password, the display shows **Password:**.
2. Enter your four-digit password.



If you forget your Call Log password, it can be deleted in programming. See “Using passwords” on page 217.





Changing your Call Log password

1. Press    . The display shows **Old Password:**.
2. Enter your old password. The display shows **New Password:**.
3. Enter your new four-digit password. The display shows **Repeat New:**.
4. Re-enter your password. The display shows **Password changed**, which confirms that your password has been changed.

Deleting an assigned password

1. Press    . The display shows **Old Password:**.
2. Enter your old password. The display shows **New Password:**.
3. Press  or **OK**. The display shows **No Pswd assigned**, which confirms that your password has been deleted.

Displays

1:Unknown name

The caller's name is unavailable.

1:Unknown number

The caller's number is unavailable.

12:KATE SMITH
NEXT ERASE MORE

_ indicates a new item.

12:KATE SMITH
NEXT ERASE MORE

⌋ indicates that the call was answered.

125KATE SMITH
NEXT ERASE MORE

Ⓢ indicates a long distance call.

49/1234567890123
NEXT ERASE MORE

↙ indicates that the stored number has been shortened to its final 11 digits. Press  or MORE to display additional information about the call.

Call(s) bumped

One or more log entries have been deleted by the Autobumping feature while you are looking at the Call Log.

Hold or release

Hold or release your active call before entering Call Log.

In use: SETNAME

The external line is in use.

Jan 4 9:00a 3X
NEXT ERASE MORE

The repeat call counter, shown along with time and date, indicates the number of calls you have received from the same caller.

Line001 ⌋27
NEXT ERASE MORE

This call was answered at another telephone (27).

Line001 ⌋Logit
NEXT ERASE MORE

This call was logged manually.

Line001
NEXT ERASE MORE

This call was not answered.

Messages & Calls

MSG CALLS

There are one or more items in your message waiting list, and there are one or more new items in your Call Log. Press **[←] [8] [0] [6]** to change the first line of the display to the current time and date.

New calls begin

You have viewed your last old log item and are now viewing your new log items.

No info to log

No information is available for the call.

No log assigned

No log space has been assigned to the telephone.

No resume item

The resume item has been removed because of Autobumping, repeat call update, or log reallocation while you are looking at the Call Log.

For other displays, see “Common feature displays” on page 243.

Using Voice mail



If you subscribe to a voice message service outside your office, you can access that service through your Norstar system. Your installer or customer service representative programs your Norstar telephone to indicate when you have a voice message waiting on a particular line.

To find out if your external voice message service works with Norstar, or if you have any problems with your service, contact your voice message service provider.

Customizing your telephone

Finding out what a button does using Button Inquiry

  0

You can check the function of any line, intercom, or programmed button on your telephone by pressing   0.

On the 7000 and 7100 digital phones, Button Inquiry shows the internal number of the telephone, followed by the function assigned to the memory button.



On Digital Mobility phones, this command displays the internal number of the telephone.

Displays

```
001 <LINENAME>
      SHOW      OK
```

The display shows the number and name of the line. Press SHOW to view the redirection status of the line.

```
123456789012345...
      VIEW→     OK
```

Press  or press VIEW→ or ←VIEW to view a number that is too long to fit on the display. Press  or OK when you are done.

```
21 <SETNAME>
NEXT  VIEW→
```

The display shows the directory number of the telephone, and the assigned name. Press NEXT to see the first line assigned to ring at the intercom button.

```
<Feature name>
      SHOW      OK
```

The name of the feature assigned to a button is displayed when you press the button. Press  or SHOW for additional information.

```
Press a button
EXIT
```

Press the button you want to check. Press  or EXIT when you are finished.

For other displays, see “Common feature displays” on page 243.

Changing the set display contrast

Use this feature to adjust the contrast of system digital telephones.

1. Press **[☎] [*] [7]**.
2. Press a number on the dialpad to choose the contrast level you like best.

On a two-line telephone, you can use the **UP** and **DOWN** display buttons to adjust the contrast.

The number of contrast levels available varies from one telephone model to another.

Changing the language on the display

You can select the language used on the display of each system telephone. Which languages are supported depends on the profile for your system. Profile 1, the default profile, supports three languages: English, French and Spanish. When your system is first installed, all telephones use English.

Profile 2 also supports Turkish.

If you program **[☎] [*] [5] [0] [1]** on to a memory button, you can then simply press the button until the language you want appears on the display. You cannot program **[☎] [*] [5] [0] [2]** or **[☎] [*] [5] [0] [4]** onto a memory button.

- English: Press **[☎] [*] [5] [0] [1]**.
- French: Press **[☎] [*] [5] [0] [2]**.
- Spanish: Press **[☎] [*] [5] [0] [3]**.
- Turkish: Press **[☎] [*] [5] [0] [4]**

The Digital Mobility phones have both system-based and handset-based prompts. This feature only changes the system-based prompts. The handset has an administration code to change the handset-based prompts.



Programming a feature code onto a memory button



















You can program a feature code onto a memory button. In some cases, pressing the button a second time cancels the feature.

Programming feature buttons

Any memory button not programmed as an external or internal line, target line, Answer button, or handsfree/mute button, is available for features.





1. Press   .
2. Press the memory button you want to program with a feature.
3. Enter the appropriate feature code you want to assign onto the button.

The following feature codes cannot be programmed onto a memory button: Long Tones and any code beginning with  except      (Language Choice),    (Contrast Adjustment), and the SWCA buttons      to     .



Tip - When you program a button with the line pool feature code, you must enter a line pool access code after the feature code. The programmed line pool button accesses a specific line pool, not the line pool feature.

Erasing a feature button

1. Press   .
2. Press the feature button.
3. Press  or **OK** to erase the button.

Displays

```
<Feature name>
      SHOW      OK
```

The name of the feature assigned to a button is displayed when you press the button. SHOW appears when there is more information available. Press **#** or SHOW for additional information.

```
Enter code:
```

If you are checking a speed dial button, enter the three-digit speed dial code that you want to check.

```
F_
QUIT      CLEAR
```

Enter the feature code, or press **☎** or QUIT to quit programming or CLEAR to clear the numbers you have entered. The system accepts the entry as soon as you enter a valid feature code.

```
Feature code:
QUIT
```

Press **☎** and enter the feature code you want to assign to the button. You cannot enter invalid codes.

```
Feature moved
```

You have programmed a button with a feature that was already programmed onto another button. The feature has moved to the button you just programmed. Its original button is now blank.

```
Press a button
EXIT
```

Press the button you want to check. Press **☎** or EXIT when you are finished.

```
Program and HOLD
```

Enter the number you want to program and press **☎**. To erase the button, just press **☎**.

```
Program and OK
QUIT      OK
```

Enter the number you want to program and press OK. To erase the button, just press **☎** or OK.

For other displays, see “Common feature displays” on page 243.

Labeling your set

The Business Series Terminals have label strips that come with each set. The Norstar M-series telephones have individual keycap labels. This section suggests the process for setting up the labelling for your telephone.

Applying button labelling

Before you apply button labels, use the Button Inquiry feature (☎ * 0) to verify the button functions, and to avoid activating features as you put the labels onto the buttons. For more information refer to “Finding out what a button does using Button Inquiry” on page 145.

Digital phones

The Digital phones telephones are labelled beside the buttons. You can use the Desktop Assistant utility to make changes and print a new label card. Your system administrator can access this application from the system CD or it can be downloaded from www.nortel.com.

Digital phone button label locations

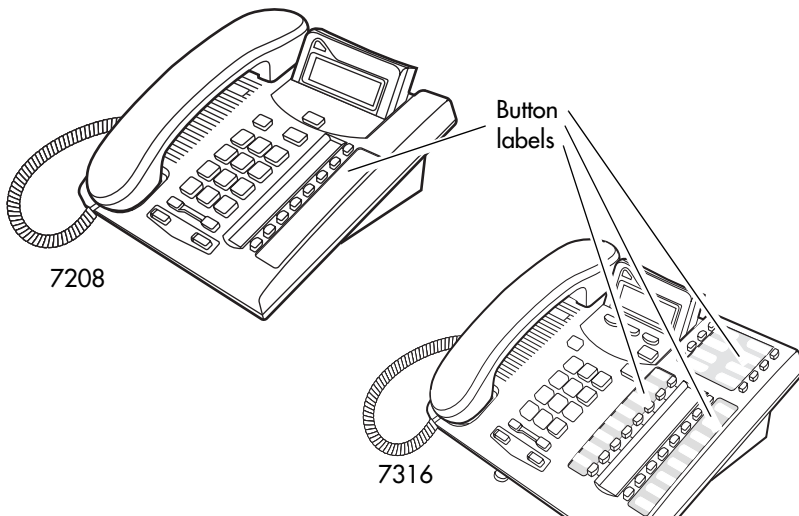

Default button assignments

During Startup, the installer chooses one of the available templates. Default features are assigned automatically to the programmable buttons on installed telephones. These defaults vary based on the chosen template, and the telephone model. The Programming Record also contains a list of default settings.

The default features are listed below.



Tips - *Please consult your customer service representative to determine the type of template programmed into your system. Not all templates are available in all software loads.*

7316E button defaults

Refer to your Programming Records to identify the current button programming for each telephone or group of telephones.

- This telephone has separate handsfree, mute and headset buttons under the dial pad.
- The current incoming call on this telephone defaults to the voice path last used. For example, if you answered the previous call using your headset, the next call will come in over your headset.
- Line numbering starts on button 09.

7316E

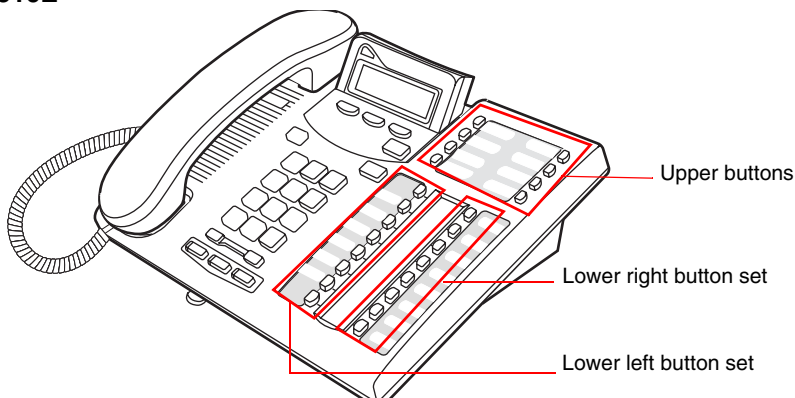

7316E upper buttons

Upper right buttons			
PBX	Hybrid	Square	Btn #
Contrast			01
Show time			02
(blank)	Privacy		03
(blank)			04

Upper right buttons			
Btn #	PBX	Hybrid	Square
05	(blank)	Saved No.	
06	(blank)	Sys Park	
07	Send Msg.		

7316E lower buttons

Lower left buttons					Lower right buttons	
PBX		Hybrid	Square		Btn #	All templates
Sys Park	Line <XXX>		(blank)	09	17	Call Timer
Saved No.	Line Pool	Line <XXX>	Call Fwr	10	18	Ring Again
Call Forward			Pickup	11	19	DND
Pickup			Page	12	20	Conf/Trans
Page			Transfer	13	21	Last No.
Transfer			Time/Date	14	22	Voice Call
Time/Date			Leave msg	15	23	Intercom
Receive msg			Flash	16	24	Intercom



Upgrade programming note:

The 7316E digital phone uses 7316 programming when connected to systems running software prior to CICs 6.1. When those systems are upgraded to CICs 6.1 or newer software, the telephone converts to 7316E programming, which means that all assigned memory buttons are erased. As well, the line assignments, Answer DN assignments, and intercom buttons change to the 7316E default positions. Refer to the default assignments for both telephones.

7316 button defaults

Refer to the Programming Record to identify the current button programming for each set or group of sets.

Note the button numbering for some of buttons of this telephone are not consecutive. This is because the buttons are mapped to a legacy telephone that had a second level of memory buttons on the top pad. However, since there is no second level to the memory buttons on the 7316, the button numbers only reflect the lower level. In Button programming, however, the absent button numbers appear, but they are not valid programming for this telephone.

This telephone has separate mute and headset buttons under the dialpad. Handsfree is assigned to the bottom button on the lower right column of memory buttons on the telephone.

7316

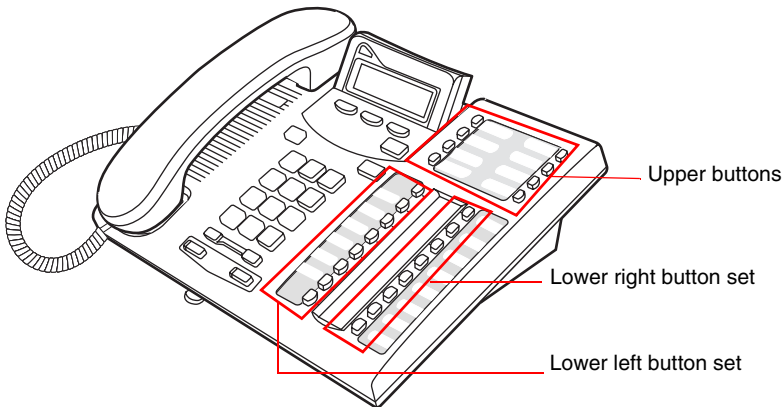

Note: These examples show defaults for a system with three-digit internal numbers. The defaults do not actually exist on any telephone, as no telephone has an autodial button for itself. The position that would be taken by the autodial button for itself, is blank.

7316 upper buttons (all templates)

Btn #	Left buttons		Btn #	Right buttons
23	Set: 227		31	Set: 231
25	Set: 228		33	Set: 232
27	Set: 229		24	Set: 239
29	Set: 230		26	Set: 240

7316 lower buttons

Lower left				Lower right	
PBX	Square	Hybrid	Btn #		
	Set: 221		11	17	Set: 224
	Set: 222		13	19	Set: 225
	Set: 223		15	21	Set 226
DND	Line <XXX>		01	06	Conf/Trans
Transfer	Line <XXX>	Line Pool	02	07	Last No.
	Call Fwd		03	08	Voice Call
	Pickup		04	09	Intercom
	Page		05	10	Intercom

7208 button defaults

The default button assignments for the 7208 telephones are the same, depending on which template was applied.

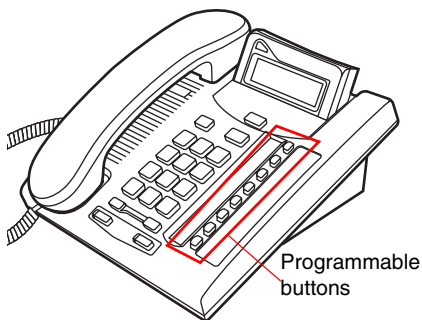

7208 button defaults

Btn. #	PBX	Square	Hybrid
01	Pick up	Line <XXX>	
02	Transfer	Line <XXX>	Line pool
03	Last No.		
04	Page		
05	Conf/Trans		
06	Speed dial		
07	Intercom		
08	Intercom		



Tips - *The default Page button activates the External Page option ().*

7100 button defaults

For all templates, the one programmable button on the 7100 telephones is defaulted to Last Number redial.

Rules of default button assignment

- Line and intercom buttons are assigned by default templates and can be changed in programming.
- Handsfree and answer DN buttons are not assigned by default. If these features are defined, however, they are automatically assigned to specific buttons, as described on this and the following page.
- The handsfree/mute feature appears on the bottom right-hand button on the M-series telephones, moving the Intercom button(s) up one position. The Business Series Terminals have a separate mute button located under the numeric dialpad, beneath the volume rocker button. The 7316E digital phone also has a separate handsfree button beside the mute button, however, this button only works if the telephone is connected to a system that is running version 6.1 or newer software.
- Each telephone can have up to eight answer DN buttons. They are assigned to buttons above assigned intercom buttons, continuing up the button column, replacing the features on those buttons. On the 7208 digital phones, answer DN buttons appear above the intercom buttons and below external line buttons, in a single column. On the 7000 and 7100 digital phones and the Digital Mobility phones, answer DNs do not have line appearances, so they must be set to ring-only.
- External line buttons appear starting at the top button in the left column, moving down the row of buttons. Telephones with two rows of memory buttons allow line assignments to continue from the top of the right column of buttons when the left column of buttons are all assigned.

Line buttons have priority over feature access buttons but not handsfree, intercom, or answer DN buttons.





The 7316 starts lines at button 01, which is the fourth button down, on the left side of the lower button set.

The 7316E starts line numbering at button 09, which is the left top corner of the lower button set. Refer to the default charts for specific button placement for these telephones.

Moving line buttons



You can move external lines to different buttons on your telephone to arrange your lines in the way that makes the most sense to you. If you have an eCAP, you cannot move intercom or Answer DN assignments onto the module, but you can move your lines over to the modules. If you have a 7316E+eKIM eCAP, you can move lines, target line appearances and hunt group appearances over to the KIM.

1. Press    .
2. Press the button you want to move the line from.
3. Press the button you want to move the line to.

Displays

Exchanged

The two buttons you selected have exchanged position.

Invalid location

You have tried to move a line to a button that cannot be used as a line button, such as an intercom button, handsfree/mute button, or an answer button.

Move line from:

QUIT

Press the button of the line you want to move. Press  or **QUIT** when you have finished moving lines.

Move line to:

QUIT

Press the button you want to move the line to. Neither of the buttons is erased. The lines, or the line and feature, simply switch places.







Press a line

The button you are trying to move is not a line button. If you are trying to switch a line and a feature, move the line to the feature button and not the feature button to the line.

Changing the type of ring

 * 6

You can choose one of four distinctive rings for your telephone. This makes it easier to identify your telephone in an open office.



1. Press  *  6 .
2. Press  1 ,  2 ,  3 ,  4 , or **NEXT**. You hear the selected ring for two seconds.
3. Repeat until you hear the ring you prefer, then press  or **OK**.



TIP - *The Digital Mobility phone has access to a number of ring patterns, but these are controlled by the handset. This setting does not affect the handset.*

Adjusting the Ring volume

 * 8 0

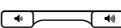
1. Press  *  8 0 . The telephone rings.
2. Press  to adjust the volume; left end for lower and right end for higher.



TIP - *The Digital Mobility phone has a volume adjustment, but it is controlled by the handset. This setting does not affect the handset.*

Hiding the message or calls indication

[e] 8 0 6

The display that shows you have messages or calls can be replaced with the current time and date. You can retrieve your message and call information by using the display buttons that appear on the second line of the display.

If you are using a telephone with a single-line display, the message or call indication is hidden.

1. Press **[e] 8 0 6**. The current time and date appears on the top line of the display.
2. Press **MSG** or **[e] 6 5** to see your messages, or press **CALLS** or **[e] 8 1 2** to see your calls.

Restoring the messages and calls indication

Press **[e] # 8 0 6**

User Preferences

The User Preferences section of programming allows you to program memory buttons, speed dial codes and other settings for any Norstar or BST telephone on the system.

For example, an employee may want to have the Do Not Disturb feature programmed onto a memory button or may want to create a speed dial code. Instead of programming from the employee's telephone, you can go into programming on the telephone nearest you to make the change.

Using User Preferences

1. Press ().
2. Enter the Basic password (the default passwords is).
(Note: You can also use the Coordinator password to change User preferences.

By using a Basic password, it is possible to have someone else do day-to-day upkeep of telephones without giving out access to sensitive programming. See “Using passwords” on page 217.

After you enter the proper password, the display shows you the telephone with the lowest internal number followed by its name (For example, **21:RECEPTN**).

1. Press to move through all the telephones on the system.
2. Press when you see the telephone you want to change. The display shows the model number of the telephone at the extension. The display shows **Connect set** if no telephone is connected at that internal number. You cannot make changes if the model is **Other**.
3. Press to move through all the subheadings in User Preferences.

User Preferences programming is available under **User Preferences** under the heading **Terminals&Sets**.

Changing button programming

Press at **Button Programming**. The display shows the number of buttons on the telephone (an example is shown in Displays at the end of this section).

If the telephone has a CAP module, you can press **CAP1** or **KIM1** to see the buttons on the module.

Press to move through all the buttons on the telephone. Refer to “Default button assignments” on page 150 for button number mapping for each type of Business Series Terminal and Norstar M-series telephones.

Use the display buttons to change the programming for a button. User Preferences programming cannot change the buttons that are used by lines, intercom, and the handsfree feature, which are assigned by the system administrator. Refer to the *Compact ICS 7.0 Installer Guide* for details.

The display buttons used in button programming

- CANCL** Moves you out of a setting without making any changes to it.
- CLR** Erases the button.
- TEL#** Programs the button as an autodial number for an internal or an external number. If it is an external autodial number, you have to choose a line, line pool, or the routing table for the call to use.
- CHANGE** Used when you are setting up an external autodial number. Press **CHANGE** until you see the type of line or pool you want the number to use.
- FEATR** Press to store a feature code on the button.
- FIND** Locates a specific button on a telephone by entering its number. Button numbers are shown in the illustrations.
- LIST** Takes you to a list of feature codes. Press to move through the list and press **OK** when you see the feature you want to program on the button.

Information about individual displays you may see is described at the end of this section.

Changing a User Speed Dial

1. Press at **User Speed Dial**. The display shows the number of speed dial codes that are available.
2. Press to see the first speed dial code (256).
3. Press to move through all the speed dial codes.
4. Press at the code you want to change.
5. Press **CHANGE** and enter the telephone number the same way you would dial it on the telephone.
6. Press **OK**.
7. Press and choose the line (or enter a code for a line pool) the speed dial code should use.

Use the line pool code to select a particular line pool for use with Speed Dial. If you select **Use routing tbl**, a line or pool is chosen by the routing programming according to the initial digits in the number.

The route you choose for a User Speed Dial code must be one that the telephone can use. For example, if the telephone does not have access to Line Pool B and you use that pool code with the speed dial code, the code does not work. Lines and line pools are assigned to the telephones by the system administrator. Refer to the Compact ICS 7.0 Installer Guide for details.

To change a system speed dial code, see “Adding or changing a system speed dial” on page 29.

Changing Call Log options

1. Press at **Call log opt'ns...**
2. Press **CHANGE** until you see the option you want to use. See “Call Log options” on page 138

Changing how calls are dialed

1. Press at **Dialing opt'ns...**
2. Press **CHANGE** until you see the option you want to use.

Descriptions for dialing options are found on the *Telephone Feature Card*, or see “Changing how you dial your calls” on page 75.

Changing the language used on the display

Press CHANGE at **Language:** until you see the language you want to use.

For language choices see “Changing the language on the display” on page 146

Making the display lighter or darker

Press CHANGE at **Display contrast** until you see the value you want to use.

The display contrast on the telephone you are using for the programming session does not change when you are programming another telephone.

Changing the ring on the telephone

At **Ring type:**, press CHANGE until you see the option you want to use.

Descriptions for ringing options are found on the *Telephone Feature Card* or in “Changing the type of ring” on page 157.

Displays

```
10+24 buttons
                FIND
```

There are 10 memory buttons and 12 dual memory buttons on the telephone you are viewing. Press to begin looking at what is on each button.

```
B01:L06:Line 001
                FIND
```

A line appears on the button. You cannot store a feature or number on it.

```
B02:#Reply Msg...
CLR   TEL#  FEATR
```

A feature is stored on this button. Press to see the feature code. A full list of names and codes for features is included in the index.

```
Code:F#65...
CLR   TEL#   FEATR
```

Shows the feature code stored on a button. Press to see the button number and feature name.

```
B03:160455512...
CLR   TEL#   FEATR
```

The button has a telephone number stored on it. Press to see the rest of the number.

```
Extern1 tel #...
CLR   TEL#   FEATR
```

The autodial is an external number. Press to see what line or pool the call is programmed to go out on.

```
Intern1 tel #...
CLR   TEL#   FEATR
```

The autodial is an internal number. Press to see more information.

```
B04:Intercom...
                                FIND
```

The button is used for intercom. Press to see more information about the button. You cannot store a feature or number on it.

```
B05:Ansr 93
                                FIND
```

The button is used for an Answer DN. You cannot store a feature or number on it.

```
B06:Blank button
CLR   TEL#   FEATR
```

Either nothing is stored on the button or you have just cleared the button by pressing CLR.

```
B10:Handsfree
                                FIND
```

The button is occupied by the handsfree feature. You cannot store a feature or number on it.

For other displays, see “Common feature displays” on page 243.

Programming Hunt Groups

The Hunt Groups feature allows a group of (Norstar or Business Series Terminals) BST telephones to be called by a single directory number, ensuring that calls are easily routed to the appropriate group.



The Incoming Line Group (ILG) functionality is now accomplished through the Hunt Group feature. When upgrading from a pre-Compact ICS 4.0 system to a Compact ICS 7.0 system, any lines previously belonging to an ILG are not automatically converted to broadcast Hunt Groups. You must go in and program them to the new feature. Please refer to “Assigning or unassigning lines to a group” on page 168.

Hunt Groups are used in situations where a group of people performing the same task are required to answer a number of related phone queries. Some typical uses of Hunt Groups are:

- a sales department answering questions on product prices or availability
- a support department answering questions concerning the operation of a product
- an emergency department answering calls for help.

Hunt Groups can be used to route calls to a support service such as a Help Line for a software company. Specialists dealing with Product A can be in one group, and specialists dealing with Product B can be in another group. Incoming calls hunt for the next available telephone in the group. If no telephone is available, the call can be placed in a queue or routed to an overflow set.

The Hunt Groups subheading in system programming is the area where programming changes are made to the following:

- members of a group
- position of a group member
- what lines are assigned to a group
- how incoming calls are distributed
- how long the system looks for available members

- where a call goes if all members are busy

Note: Videophones should not be placed in Hunt Groups. Hunt Groups allow one B channel connection at a time and videophones use two B channels.

Features affected by Hunt Groups include:

- Auto Attendant
- Call Forward All Calls
- Call Forward No Answer
- Call Forward on Busy
- Group Pickup
- Transfer via Hold
- Priority Call
- Line Redirection
- Page Zones
- Voice Call

Note: Fixed external cadencing is provided for all external Hunt Group calls regardless of whether or not they have been answered and transferred.

Adding or removing members from a group

A DN can be associated with a member of a Hunt Group and is called a member DN.

Members of the group can be any Norstar or BST telephone or ISDN terminal. A Norstar or BST telephone can be in more than one Hunt Group but is considered a member in each Hunt Group, increasing the total number of members in the system.

There can be only one appearance of the Hunt Group on a telephone, no matter how many lines are assigned to the group.

Hunt Group DNs cannot be members of other Hunt Groups.

5. Press **MOVE** to move an existing member to another place within the Hunt Group. The display shows the member number followed by an arrow.
6. Enter the new position number for the extension.
7. Press  to exit or to continue programming.

Assigning or unassigning lines to a group

You can assign one or several lines to a hunt group.

Hunt group line notes:

- Configure the prime set for a Hunt Group line to **None** to avoid delayed ring transfer of external Hunt Group calls to the prime set before the Hunt Group can receive the call.
- A line can be assigned to only one group.
- Do not assign any hunt group lines to individual telephones. If any of the telephones that are part of the hunt group have the line assigned, remove the line from the telephone before assigning it to the hunt group.

1. At **Hunt groups**, press . The display shows **Show group**.
2. Enter the Hunt Group number you want to program (1-6) or press to scroll through the groups.
3. Press . The display shows **Member DNs**.
4. Press . The display shows **Line assignment**.
5. Press . The display shows **Show line**.
6. Enter the line number you want to program and press **SCAN** to go to the first line assigned to this group, or press **LIST** to go to the first line in the system.
7. Press **CHANGE** to program the line as **Unassigned** or **Assigned**.
HGnn means the line is assigned to another Hunt Group.
8. Press  to exit or to continue programming.

Setting the distribution mode

There are three modes of call distribution:

- **Broadcast**—rings each telephone in the group simultaneously. Calls are handled one at a time. Subsequent calls are queued. As soon as a call is picked up, the call next in the queue is presented to the Hunt Group without having to wait for queue time-out.

In Broadcast mode, a single incoming call rings simultaneously at all the telephones in a group. This way, all receptionists in the group can share the load of answering large volumes of calls. All telephones automatically display the calling line identification (CLID), if available. A familiar example is a fund-raising campaign where a group of operators are waiting to take each call as it comes in.

- **Sequential**—starts the call at the first telephone in the Hunt Group and distribution is complete when the first idle telephone has been found. Simultaneous calls can be presented. Distribution is order based.

In Sequential mode, you can program your top salesperson to be the first member of the group to receive incoming calls.

- **Rotary**—the call starts at the telephone after the one which answered the last call. Distribution is complete when the next idle telephone has been found. Simultaneous calls can be presented. Distribution is order based.

In Rotary mode, you can ensure that all your helpline people are receiving calls on an equal basis, rather than one person receiving the majority of calls. The call rings at one set at a time in a round robin fashion.

If a Hunt Group has available members but nobody answers the call, the call is rerouted through the list until someone answers the call. If all lines are busy, the call is routed according to whatever has been set for the busy line setting. Refer to ‘Programming busy line setting’ on page 170.

1. At **Hunt groups**, press . The display shows **Show group**.
2. Enter the Hunt Group number you want to program (1-6) or press to scroll through the groups.
3. Press . The display shows **Member DNs:**.
4. Press until the display shows **Mode**.
5. Press **CHANGE** to set the mode: **Sequential, Rotary, Broadcast**.

6. Press  to exit or to continue programming.

Setting the hunt delay

This setting allows you to program the number of rings the system permits at a Hunt Group set before moving on to the next telephone in the Hunt Group.

1. At **Hunt groups**, press . The display shows **Show group**.
2. Enter the Hunt Group number you want to program (1-6) or press to scroll through the groups.
3. Press . The display shows **Member DNs:**.
4. Press until the display shows **Hunt delay**.
5. Press **CHANGE** to select the setting: **1, 2, 3, 4, 5, 6, 7, 8, 9, 10**.
6. Press  to exit or to continue programming.

Programming busy line setting

A Hunt Group is considered busy if either of these two scenarios exist:

- all of its members are being presented an incoming Hunt Group call
- all of its members are active on a Hunt Group call

There are three routing options if all members are busy:

- BusyTone—the caller gets a busy tone
- Overflow—the call is routed to an overflow position
- Queue—the call stays in the system for a period of time. Within this period of time, the call is presented to a member if one becomes available. When the time-out occurs, the call is presented to an overflow position.

1. At **Hunt groups**, press . The display shows **Show group**.
2. Enter the Hunt Group number you want to program (1-6) or press to scroll through the groups.
3. Press . The display shows **Member DNs:**.
4. Press until the display shows **If busy:**.

5. Press **CHANGE** to set the mode: **BusyTone**, **Overflow**, **Queue**.
6. Press  to exit or to continue programming.

Programming the queue time-out

This setting allows you to program the number of seconds a call remains in the Hunt Group queue before it is routed to the overflow position.

1. At **Hunt groups**, press . The display shows **Show group**.
2. Enter the Hunt Group number you want to program (1-6) or press to scroll through the groups.
3. Press . The display shows **Member DNs:**.
4. Press until the display shows **Q Timeout:**.
5. Press **CHANGE** to set the queue time-out: **15**, **30**, **45**, **60**, **120**, **180**.
6. Press  to exit or to continue programming.

Programming the overflow set

This setting allows you to program the overflow telephone to which the Hunt Group calls are to be routed. Unless the overflow position is a Hunt Group telephone, the call ceases to be a Hunt Group call. If the overflow telephone is a Hunt Group telephone, the call is treated as a new call and goes to the bottom of the queue.

The overflow telephone can be a DN number associated with a voice mailbox.

1. At **Hunt groups**, press . The display shows **Show group**.
2. Enter the Hunt Group number you want to program (1-6) or press to scroll through the groups.
3. Press . The display shows **Member DNs:**.
4. Press . The display shows **Overflow:**.
5. Press . The display shows **Overflow:HGrp**.
6. Press **CHANGE** to change the overflow position.
7. Enter the new overflow position.

8. Press  to exit or to continue programming.

Setting the name

This setting allows you to program the Hunt Group name, such as SERVICE or SALES. The name can be up to seven characters in length. This name becomes the CLID display name when the DN is called.

1. At **Hunt groups**, press . The display shows **Show group**.
2. Enter the Hunt Group number you want to program (1-6) or press to scroll through the groups.
3. Press . The display shows **Member DNs**.
4. Press . The display shows **Name**.
5. Press **CHANGE**.
6. Using the dialpad, enter the name of the Hunt Group.
7. Press to store the name.
8. Press  to exit or to continue programming.

Allowing/disallowing an auxiliary ringer

This setting allows you to allow/disallow an external ringer to sound when a call comes in for a specific hunt group. If you allow this service, you must have an auxiliary ringer properly installed on your system. Refer to “Using an auxiliary ringer” on page 224.

1. At **Hunt groups**, press . The display shows **Show group**.
2. Enter the Hunt Group number you want to program (1-6) or press to scroll through the groups.
3. Press . The display shows **Member DNs**.
4. Press until the display shows **Aux. Ringer**.
5. Press **CHANGE** to choose **Y** (yes) to turn the ringer on or **N** (No) to disallow an auxiliary ringer.
6. Press  to exit or to continue programming.

Assigning a distinctive ring pattern to a Hunt Group

You can assign distinctive ring patterns to your Hunt Group so that calls can be rated in priority for the group. These distinctive ring patterns, have the same characteristics as for line and extension distinctive ring patterns. Refer to “Changing the ring on the telephone” on page 162.

Note: Digital Mobility phones that are members of hunt groups do not reflect this feature.

The Hunt Group distinctive ring pattern determines how a call will ring within the Hunt Group. If members of the group have ring patterns assigned to their telephones that are higher than the ring patterns of the incoming line or the Hunt Group, then the Hunt Group will use the ring of the corresponding member telephones.

If the incoming call (line) has a higher ring pattern assigned than the Hunt Group, the Hunt Group will ring with the line ring pattern.

1. Find the heading **Hunt Groups**.
2. Press . The display shows **Show Group**.
3. Enter the Hunt Group number you want to program (1-30).
4. Press . The display shows **Member DNs:**.
5. Press until the display shows **Distnct Ring: NONE**.
6. Press **CHANGE** to toggle to the ring pattern number you want to assign to the Hunt group line. (**None, 2, 3, 4**)
7. Press to exit or to continue programming.

Using Silent Monitor

After you have the silent monitor parameters set up, you will be able to use your SM supervisor two-line display telephone to monitor external Hunt group calls.

Note: Digital Mobility phones cannot be used as a supervisor telephone for silent monitoring.

Refer to the *Compact ICS Installation Guide* for detailed information about the fields that make up this feature.

To start a session, on a silent monitor supervisor telephone:

1. Enter .
2. Type in the SM password (default: `SILENT <745368>`)
3. Enter the DN of the telephone you want to monitor and press OK.

If that telephone is currently on a Hunt group call, you will be automatically connected to the call. If the telephone is idle or not on a hunt group call, you will be prompted to pick another DN to monitor.



Tips - *Your telephone is muted by default at the beginning of a monitoring session. Press the mute button or the display key under JOIN to enter the conversation.*

To end a session: Press , or press the display key under OTHER or EXIT.

While attempting to monitor a call, or during a call, you may get one of the following prompts:

```
OBSERVE
  RETRY   OK
```

Enter the DN for the Hunt Group telephone that you want to monitor. If you make a mistake entering a DN number, press RETRY and re-enter the number. If the number you entered is correct, press OK.

The system redispays this prompt if it is unable to establish a session with the telephone DN that you enter.

OTHER JOIN EXIT

While a call is being monitored, you can choose to:

- move to another Hunt group member (OTHER)
- join the current conversation (JOIN)
- exit the silent monitoring (EXIT)

OTHER LEAVE EXIT

When you join a monitored call, you can choose to:

- move to another Hunt group member (OTHER)
- mute your telephone out of the current conversation (this does not disconnect silent monitoring) (JOIN)
- exit the silent monitoring (EXIT)

Access denied

You tried to start a monitoring session on a telephone that does not support the feature.

Needs Handsfree

You entered the silent monitor feature code without picking up the handset, and the telephone does not support handsfree operation.

Release calls

You entered the silent monitor feature code on a telephone that already has an active call. To continue, you will have to put that call on hold, or release it.

Your number

You entered your own DN.

Invalid number

The DN you entered is invalid for your system.

Not in Service

The DN you entered did not respond to the system.

Not HG member

The DN you entered is not a Hunt Group member.

Supervisor

The DN you entered belongs to another Supervisor. You cannot monitor SM supervisor telephones.

Not Supported

The DN you entered belongs to a portable telephone or an ISDN terminal.

DN: Idle
OTHER EXIT

The current call on the telephone you are monitoring is either not a Hunt Group call, or the call came in on a line button on that telephone.

Note: You should not assign lines which are assigned to the hunt group to individual hunt group members

Need I/C key

No intercom button is currently available to support the feature.

Feature notes

- You can only monitor external hunt group calls.
- You must release all calls on your supervisor telephone before you attempt to run a monitoring session.
- The DN you choose to monitor must be a designated member of a hunt group.
- The supervisor telephone can be part of a hunt group. Supervisor telephones cannot be monitored.
- If the hunt group call gets transferred, the session is dropped because the call is no longer a hunt group call.
- If any of the parties release the call, the monitoring session is dropped, and the supervisor will be prompted to pick another DN to monitor.
- To transfer a session to your handset when you start the monitoring session in handsfree mode, press the **OTHER** key and re-enter the DN, otherwise the session will continue on your telephone speaker.
- If your telephone is in Silent Monitor idle mode, and you press the intercom button, the monitoring session will terminate.
- You can monitor calls that are forwarded to a hunt group member.
- If the call is parked, attached to a SWCA button, put on Hold, or camped, Silent Monitor will drop the monitoring session and the supervisor will receive an indication that the hunt group telephone is now idle.
- If the current hunt group call is part of a conference call, it cannot be monitored.

- You can initiate a session on a Hunt group telephone with Do Not Disturb or Auto Privacy are active.
- Using a headset automatically defaults Silent Monitor to mute. This is the recommended way of using the Silent Monitor feature.
- Messages received by the supervisor during a silent monitoring session, will not provide an indication on the display.
- Attempting to initiate any feature buttons on the supervisor set, while a session is active, will terminate the silent monitoring session.
- A priority call or ring again call will be indicated on the display. The monitoring session will terminate if the call is accepted.
- If a line is assigned to both a ringing group and a hunt group, calls coming in over this line cannot be monitored.
- If a voice call coming into a supervisor telephone is accepted, any active monitoring session will be released.
- 7316 digital phones used as supervisor may experience problems using mute and unmute when joining or leaving a silent monitor session.

Using the Hospitality features

This section describes the Hospitality Services feature which is used to administer room and alarm services in small to medium-sized facilities such as hotels, motels, or hospitals.

There are three types of sets that make up this type of system:

Common set—this telephone can be found in the lobby, office, or common area, and is not associated with a room. This type of telephone is used for public access, and cannot access the admin or room features.

Room set—this telephone resides in a specific room and can be used by both guests and cleaning staff to set alarms or to indicate room condition. Up to five telephones can be assigned to the same room number, such as for fax lines, internet dial-up, etc.

Administration set—this telephone must be a two-line display telephone and is usually configured with a password to allow secure administration of room occupancy and condition services and alarm services.

Hospitality passwords

There are two passwords within the hospitality feature. One provides secure access to the administration set, and one provides secure access to a room condition setting from each room set for housekeeping staff.

Desk pswd

Change this password frequently, to maintain security.

1. Place the appropriate programming overlay on the set you are using to do programming.
2. Press **[☎] [*] [*] 2 6 6 3 4 4** (CONFIG). The display shows **Password:**.
3. Press **2 3 6 4 6** (ADMIN). The display shows **Terminals&Sets.**

4. Press until the display shows **HOSPITALITY**.
5. Press . **Desk Pswd:** displays. (default is 4677)
6. Press **CHANGE**. **New Pswd:** displays
7. Enter a new password, then press **OK**.

Cond pswd

Change this password frequently, to maintain security.

1. Place the appropriate programming overlay on the set you are using to do programming.
2. Press (CONFIG). The display shows **Password:**.
3. Press (ADMIN). The display shows **Terminals&Sets**.
4. Press until the display shows **HOSPITALITY**.
5. Press .
6. Press . **Cond Pswd:None** displays.
7. Press **CHANGE**. **New Pswd:** displays
8. Enter a new password, then press **OK**.

Room/desk information

There are two aspects to programming room information.

- First you must program specific DNs to a specific room and set up the room occupancy filters, which determine what types of calls can be made from a room set at various states of occupancy.
Note: You can assign up to five DNs to the same room number.
- Then you need to administer the room occupancy and state of the room.

Programming room information

Use this setting to assign set DNs to a specific room.

1. Place the appropriate programming overlay on the set you are using to do programming.
2. Press (CONFIG). The display shows **Password:**.
3. Press (ADMIN). The display shows **Terminals&Sets**.
4. Press until the display shows **Hospitality**.
5. Press until **Room/desk info** displays.
6. Press . **Show set: displays**.
7. Enter a room set number or press **LIST** and press until you find the DN of the set you want to assign to a room.
8. Press . **Room #:None** displays.
9. Press **CHANGE** and enter the room number, then press **OK**.
10. Press . **Adm Pwd re-req'd:Y** displays
11. Press **CHANGE** and choose Y or N, depending on your security requirements.

Call restrns

Call restrictions can be set up by the system administrator. Refer to the *Compact ICS Installer Guide* for details.

Service times

You can set the time when occupied rooms change from Service done to Service required. This setting affects the Room condition feature.

1. Place the appropriate programming overlay on the set you are using to do programming.
2. Press * * 2 6 6 3 4 4 (CONFIG). The display shows **Password:**.
3. Press (ADMIN). The display shows **Terminals&Sets.**
4. Press until the display shows **Hospitality.**
5. At the Hospitality heading, press until **Service time** displays.
6. Press . **Hour: 00** displays.
7. Press **CHANGE** and enter the hour (00 to 23).

If the number is less than 13, the display shows **AM**. Press **CHANGE** to select **PM**, if required. Press **OK** to accept.

8. Press . **Minutes: 00** displays.
9. Press **CHANGE** and enter the minutes (00 to 59).

Using the room/set programming

This section describes how the room occupancy and room condition settings are used.

Setting dialing filters by room state

1. Press 8 7 9.
2. Enter the Desk admin password if you are prompted for a password. The set displays: **0c of rm#:**
3. Enter the room number and press **OK**. The set displays **rrrrr:Vacant.**
4. Press the **CHANGE** display key and select the required status for the room set.

5. To program other rooms, press the **FIND** or **NEXT** display key and return to step 3.
6. Press  to exit.





Note: Setting the room state to **Vacant** cancels any outstanding alarms.

Setting the room condition



You can use this feature on a room set or administration set to:

- set the room state to service done (**Srvc done**)
- set the room state to Needs service (**Needs srv**)
- query the state of the room

Using the room set

1. Press  8 7 6 on a digital set
or  * 8 7 6 on an analog set.
2. At the prompt, set the status of the room.
Note: You may be required to enter a Room condition password.
Press  to indicate **Set to srv done**.
Press  to indicate **Set to needs srv**.
The set displays the selected prompt.
3. Press  to exit.

Using the admin set

1. Press  8 7 8.
2. Enter the Desk admin password if you are prompted for a password.
The set displays: **Cd of rm#:**
3. Enter the room number and press **OK**.
The set displays **rrrrr:Vacant**.
4. To update the condition, press **CHANGE** and select the required status.
To query the condition of other rooms, press the **FIND** or **NEXT** display keys.
5. Press  to exit.

Programming the alarm feature

If you want to allow the room sets to program wake-up alarms, there are a couple of program settings that need to be entered.

1. Place the appropriate programming overlay on the set you are using to do programming.
2. Press (CONFIG). The display shows **Password:**.
3. Press (ADMIN). The display shows **Terminals&Sets**.
4. Press until the display shows **Hospitality**.
5. Press . **Room/desk info** displays.
6. Press until **Alarm** displays.
7. Press . **Attn attempts:3** displays.
8. Press **CHANGE** until you find the number you want (1-5).
9. Press . **Retry intrvl:4** displays.
10. Press **CHANGE** until you find the number you want (2, 4, 6, or 8).
11. Press . **Attn duration: 15** displays.
12. Press **CHANGE** until you find the number of seconds you want (10, 15, 20, 30, 40, 50).
13. Press . **Time format:12 hr** displays.
14. Press **CHANGE** to choose either **12hr** or **24hr**.
15. Press . **Expired alarms** displays.
16. Press . **Notify set:None** displays.
17. Press **CHANGE** to enter a set DN to be notified.
18. Press . **Use tone:N** displays.
19. Press **CHANGE** to choose either **Y** (yes) or **N** (no).
20. Press to exit or to continue programming.





Using the Administration set to control alarms

Only a Hospitality Services set can use this alarm administration feature. This feature is also associated with a room number, and cannot be used on common sets.

Use this feature to:

- query a current or last alarm time set for a room
- assign an alarm time for any room
- change an alarm time for any room
- cancel an pending alarm for any room

To program the alarm, follow these steps:

1. Press    .
2. Enter the Desk admin password if you are prompted for a password. The set displays: **al of rm#:**
3. Enter the room number.
4. Press VIEW. The set displays **Alarm: 07:00am OFF:**.
If the alarm time is correct, press the ON/OFF display key.
If you want to change the time, enter a new four-digit alarm time.
If the clock uses a 24-hour format, enter an hour between 00 and 23, and minutes between 00 and 59. The set displays: **Alarm ON hh:mm**
If the clock uses a 12-hour format, enter the time, then when the set displays: **hh:mm AM or PM?**, press AM or PM. The set displays: **Alarm ON hh:mm**.
5. Press  to exit.

Using the alarm

To set an alarm on a digital telephone:

1. Press **[C]** **[8]** **[7]** **[5]**. The display shows **Alarm:07:00 OFF**
2. Do one of the following:
 - If the alarm is correct, press **ON/OFF**. The set displays: **Alarm:07:00am ON**. Press **DONE** to exit.
 - If you need to change the alarm time, press **CHG**. The set displays: **Enter time:**
3. To enter a new time, do one of the following:
 - If the clock uses a 24-hour format, enter an hour between 00 and 23, and minutes between 00 and 59. The set displays: **Alarm ON hh:mm**
 - If the clock uses a 12-hour format, enter the time, then when the set displays: **hh:mm AM or PM?**, press **AM** or **PM**. The set displays: **Alarm ON hh:mm**.

To set an alarm on an analog set:

1. Press **[Link]** **[*]** **[8]** **[7]** **[5]**. A tone sounds.
2. Enter a four-digit alarm time:
 - If the clock uses a 24-hour format, enter an hour between 00 and 23, and minutes between 00 and 59. A tone sounds.
 - If the clock uses a 12-hour format, enter the time, then press **[*]** to select am or **[#]** to select pm. A tone sounds.

To enter a new time, repeat the above steps and enter a new time. This overwrites the existing entry.

Canceling an alarm

Canceling the alarm time for any telephone cancels the alarm time for all the sets in the same room.

Digital set: Press **[C]** **[#]** **[8]** **[7]** **[5]**.

Analog set: Press **[Link]** **[#]** **[8]** **[7]** **[5]**.

Turning off an alarm

When the alarm rings, the user can release the ring by doing one of the following, depending on the type of telephone in the room:

Digital set: Press any button except .

Analog set: Lift and replace the handset.

 acts like a snooze alarm and will temporarily disable the alarm for a programmed period. Refer to “Service times” on page 182.

If the user is on a call when the alarm sounds, they can press any button except , which would release the call instead.

Telephone features

Installing Digital phones

If you are connecting a 7316 or 7316E digital phone for the first time, refer to the following illustrations as a guide.

Installing the 7316/7316E digital phone connections

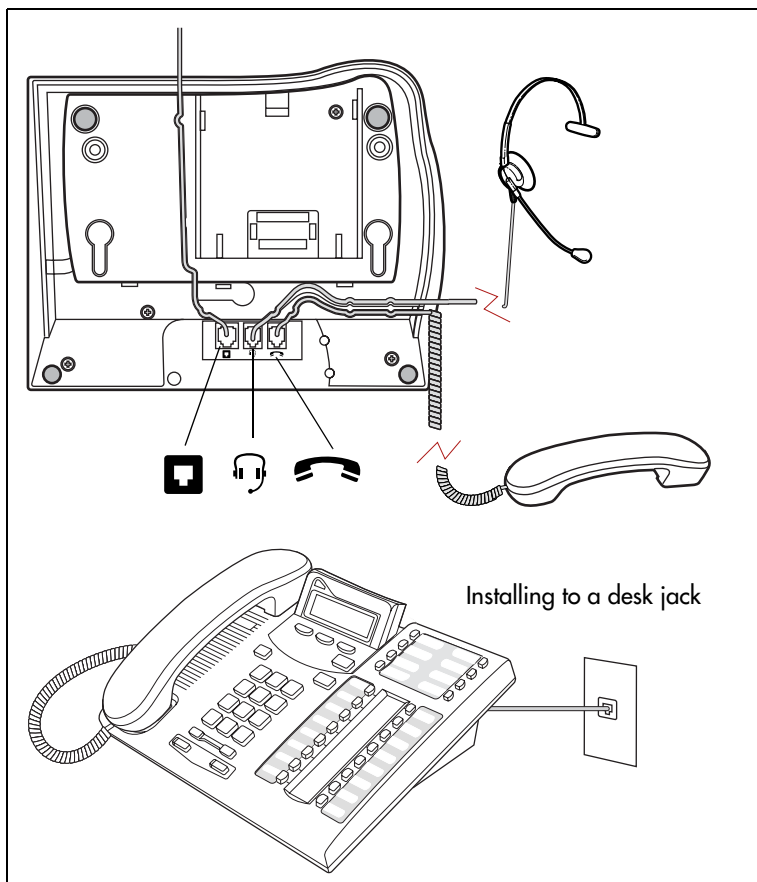

Mounting a digital phone on the wall

Mounting a 7316/7316E on the wall

Installing without the angled base

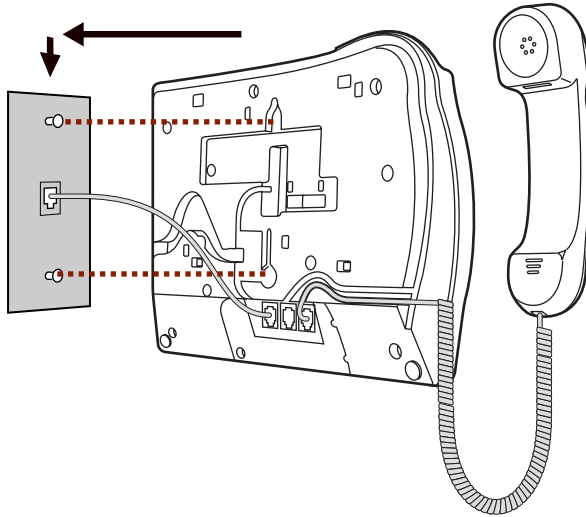

Mounting a digital phone using the stand

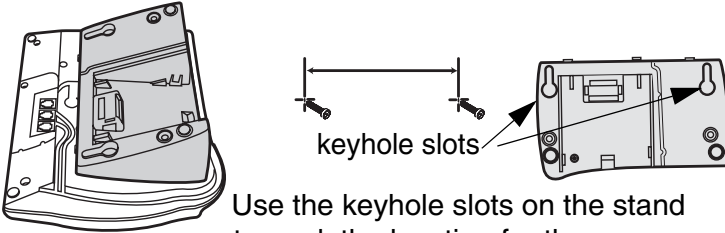

Use the keyhole slots on the stand to mark the location for the screws. Tighten screws for a secure fit.

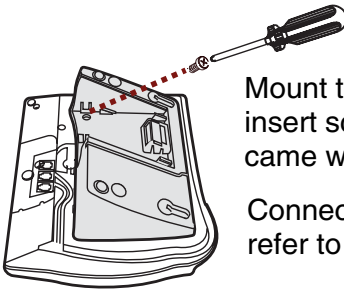

Mount the stand as shown and insert screw. Use the screw that came with your telephone.

Connect cords to the telephone, refer to cord connections

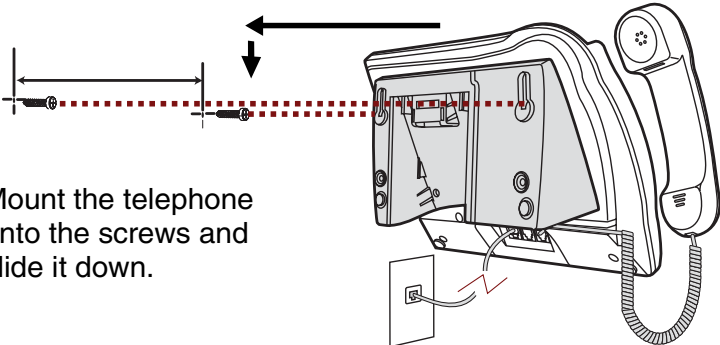

Mount the telephone onto the screws and slide it down.

Connect line cord to wall jack.

Naming a telephone or a line

You can assign names to identify external lines, target lines, and telephones assigned to specific people. During a call, the name (if programmed) is shown on the telephone display instead of the external line number or internal telephone number of the caller. Step-by-step instructions for adding or changing the name of a telephone or a line are in “Changing the name of a telephone” on page 32.

Telephone names and line names can contain both letters and numbers, but cannot be longer than seven characters. You cannot use the # and * symbols.



Tip - *You can give the same name to two or more telephones, or to a telephone and a line in your system. To avoid confusion, avoid such duplication. Use initials, abbreviations, or even nicknames to give each telephone a unique name.*

If automatic telephone relocation is turned on, the name and internal number of a telephone are saved if the telephone is moved within your system.

Moving telephones

If automatic telephone relocation is enabled in programming by your installer or customer service representative, you can move your telephone from one system jack to another without losing any of custom programming.

Stopping calls from ringing at your telephone: Do Not Disturb (DND)

Stopping calls

Press **[☎] [8] [5]** to stop calls from ringing at your telephone.

Only priority calls ring at your telephone. A line button flashes when you receive a call, but the call does not ring.

Refusing to answer a call

While you are on a call, you can refuse to answer a second call (including a priority call).

Press **[☎] [8] [5]** while your telephone is ringing.

Canceling Do Not Disturb

Press **[☎] [#] [8] [5]**.

Displays

Allow calls

Your telephone receives calls normally.

Using Do Not Disturb

Once you turn on Do Not Disturb, calls are forwarded to the prime telephone only if there is no other telephone on which the line appears. If there is another telephone that shares the same line, the call may be answered by that person. (The Delayed Ring Transfer feature transfers all unanswered calls to the prime telephone after a specified time.)

Do Not Disturb prevents voice calls from alerting at your telephone. Voice calls are presented as normal intercom calls.



Tip - System telephones that are members of a Hunt Group can temporarily leave a Hunt Group by activating this feature. Hunt Group calls arriving while a telephone is in Do Not Disturb mode are routed to the next member in the Hunt Group. For more information about Hunt Groups, see “Programming Hunt Groups” on page 165.

Using Background Music

Listen to music through your telephone speaker by pressing   .

Your installer or service representative makes this feature available through programming. You need to supply a music source, such as a radio, and have it attached to your ICS.



In accordance with U.S. copyright law, a license may be required from the American Society of Composers, Authors and Publishers or a similar organization if radio or TV broadcasts are transmitted through the Background Music feature of this telecommunication system. Nortel Networks hereby disclaims any liability arising out of the failure to obtain such a license.

Note: The 7000 and 7100 digital phones, analog phones and the Digital Mobility phones do not support this feature.

Turning Background Music off

The music stops automatically if you make or answer a call or if you press

   .

Using the device attached to the internal analog terminal adapter

The internal analog terminal adapter (I-ATA) connects a standard analog voice device to your Compact ICS. These include such devices a single-line telephone or a data communication device, such as a modem or fax machine. Unlike an external adapter, the I-ATA only supports a device that is located on the same premises as your ICS.

You activate all of the features available from the I-ATA by pressing * on your telephone and entering a feature or access code. On some telephones, you use FLASH instead of handsfree/mute.

If your telephone or device does not have handsfree/mute, you must use the Hook Switch (located under the handset) to enter feature codes. Press the Hook Switch for approximately half a second, then enter the rest of the code.

To make an external call using the device attached to the I-ATA, you must access an external line. To access an external line, lift the handset and enter the external access code. The external access code is 9 or the number programmed by your installer or customer service representative.

The feature codes for the I-ATA the telephone use * and #. If your telephone does not have *, press 1 instead. If your telephone does not have #, press 3 instead.

To make an external call, lift the handset and enter the external access code followed by the external telephone number. In most cases, the external access code is 9.

Alternate line 2

Allows you to switch between using your two intercom paths. When a path is in use, you hear an error tone informing you that the path is already in use.

- Call Forward * 4 Cancel # 4
 Directs your calls to another telephone connected to your Norstar system. Enter the feature code followed by the internal number of the telephone to receive the forwarded calls. Call Forward cannot be used with a telephone that is not connected to your Norstar system.
- Call Park * 7 4
 Parks the call on hold. The call can be retrieved from any other telephone within the system. After an external call is parked, and is not answered within a specified time, the call returns to the I-ATA. An unanswered intercom call does not return to the I-ATA
 The I-ATA can only park calls on X09. X is 1, or the number assigned by your installer or customer service representative as the call park code. You hear an error tone if you attempt to park a second call.
- Call Pick-up – directed * 7 6 <plus the ringing number>
 Allows you to answer a ringing telephone within your Norstar system.
- Call Pick-up – group * 7 5
 Allows you to answer a ringing telephone within your Norstar system.
- Call Queuing * 8 0 1
 Allows you to answer the first incoming external call to your telephone, while you are on a call. All other incoming callers hear a busy signal unless there is another telephone programmed to ring for the call.
- Camp-on * 8 2 <plus internal number>
 Allows you to reroute an external call to another Norstar system telephone.
- Class of Service password * 6 8 <plus a COS password>
 Allows you to override restrictions on the telephone or line using a Class of Service password before you enter the restricted number.

ConferenceLink * 3

Allows you to establish a three-way conference between you, one external caller and one intercom caller. To establish a conference call:

- Make or answer the first call.
- Enter Link 2 . This automatically puts the first caller on hold.
- Make or answer the second call. If the second caller is busy, replace the handset and enter Link 2 to return to the first caller.
- Enter Link * 3 to complete the conference call.

Conference Hold

Allows you to put the two conferenced callers on hold. The held callers remain conferenced. To put the conference on hold:

- Enter Link 2 to put the two conferenced callers on hold.
- Enter Link 2 to restore the three-way call.
-

Split Conference

Allows you to alternate between two parties in a three-way conference call. To consult with one caller and put the other caller on hold:

- Enter Link # 3 to split the conference.
- Enter Link 2 to alternate between calls.
- Enter Link * 3 to restore the three-way call.

Disconnecting One Party

Allows you to disconnect one party in a three-way conference call. To disconnect a party:

- Enter Link # 3 to put one caller on hold. You are connected with the other call.
- Replace the handset.
- Lift the handset and enter Link 2 . You are connected with the caller on hold.

HoldLink 2

Allows you to put an active call on hold and allows it to be picked up from other telephones. When Tones are turned on, a held call reminder tone is heard on external calls only.

Retrieve a call on Hold.

Enter Link 2 .

Hold (continued)	<p>Exclusive Hold</p> <p><input type="text" value="Link"/> * 7 9</p> <p>Allows you to put an active call on hold and prevents it from being picked up from other telephones. When Tones are turned on, a held call reminder tone is heard on external calls only.</p>
Last Number Redial	<p><input type="text" value="Link"/> * 5</p> <p>Automatically dials the last external telephone number you dialed.</p>
Link	<p><input type="text" value="Link"/> * 7 1</p> <p>Generates a Link signal to access non-Norstar features available from other systems or carriers.</p>
Line pools	<p>A line pool allows several telephones to access a group of lines used for outgoing calls. To access a line pool:</p> <ul style="list-style-type: none"> • Enter the line pool access code. OR • Enter <input type="text" value="Link"/> * 6 4 <plus the line pool code>.
Messages	<p><input type="text" value="Link"/> * 1 Cancel <input type="text" value="Link"/> # 1</p> <p>Generates a longer Link signal. Use this feature when you want to release a call from your line but retain the use of the line for another call.</p>
Page	<p><input type="text" value="Link"/> * 6 0 <plus code 1-3> <plus zone 0-6></p> <p>Allows you to make an announcement to all Norstar telephones programmed to receive a page, as well as any other connected paging equipment. You must enter a paging zone. See "Paging" on page 125 for more information.</p> <p>Page (Intercom)</p> <p><input type="text" value="Link"/> * 6 1 <plus zone code></p> <p>Page (External)</p> <p><input type="text" value="Link"/> * 6 2</p> <p>Page (Intercom and External)</p> <p><input type="text" value="Link"/> * 6 3 <plus zone code></p>
Pause	<p><input type="text" value="Link"/> * 7 8</p> <p>Generates a 1.5-second delay in the sequence of numbers you are entering (for Tone or Pulse dialing).</p>

- Priority Call** * 6 9
 Allows you to interrupt an internal call in progress on a Norstar telephone using Voice Call Deny or Do Not Disturb. The calls at the telephone you are calling are automatically put on hold.
 Telephones must be programmed to use Priority Call. See “Priority Call” on page 77 for more information.
- Privacy** * 8 3
 Prevents another telephone that shares your line from joining your current call, or permits another telephone that shares your line to join the call.
- Ring Again** * 2 Cancel # 2
 Allows you to queue a call to another Norstar telephone that is busy or is not answered, or to a busy line in a line pool. You can only use Ring Again on calls placed on an intercom line. When the telephone is available, you are alerted with one short ring from your telephone.
- Reply to a Ring Again signal** To connect with a Ring Again request when you are on a call (or your telephone is off-hook):
- Enter 2 . This automatically places your call on hold.
 - To return to the caller on hold, enter 2 .
- To connect with a ring again request when your telephone is on-hook:
- Lift the handset. The Ring Again number is automatically redialed.
- If you do not respond to the Ring Again signal within 30 seconds, Ring Again is canceled.
- Saved Number Redial** * 6 7
 Allows you to save an external number while you are on a call or while the called telephone is ringing. To automatically redial the saved number:
- Enter * 6 7 .
- System Speed Dial** * 0 <plus the speed dial code>
 Allows you to use a speed dial code to quickly dial preprogrammed telephone numbers. See “Using Speed Dial” on page 99 for more information.
 You cannot program personal speed dial numbers for the telephone connected to the I-ATA.

Timed Release * 7 2

Generates a longer Link signal. Use this feature when you want to release a call from your line but retain the use of the line for another call.

Transfer Allows you to transfer a call. To transfer a call you must have an available intercom line.

- Enter * 7 0 .
- Enter the transfer destination number.
- Replace the handset.

To Transfer using Conference

- Enter 2 .
- Make the second call.
- Enter * 3 .
- Replace the handset.

Trunk Answer * 8 0 0

Allows you to pick up a ringing external call on a line for which Ringing Service is turned on.

Voice Call * 6 6 <plus the intercom number>

Allows you to make a voice announcement or begin a conversation through the speaker of a Norstar telephone without making the telephone ring.

Using a data communication device with the I-ATA

The internal analog terminal adapter (I-ATA) can connect a data communication device such as a fax machine, modem or answering machine to the Compact ICS. In some cases, these devices require additional programming to work properly.

Turning off tones that can interfere with data transmissions

The tones used for Held Line Reminder, Call Waiting, and Ring Again can disrupt the operation of a device or the transmission of data. Lift the handset and enter * 8 0 9 to turn these tones off for the device. Enter # 8 0 9 to turn the tones back on.

Programming answering machines or modems to answer calls automatically

The device connected to the Compact ICS using the I-ATA can ring for an external line, or be set up to ring when Ringing Service (Night Service) is turned on. Contact your installer or customer service representative to have these features programmed for your system.

Using the I-ATA with modems and fax machines

The I-ATA is designed to be compatible with commercial fax and modem equipment. The Compact ICS has been shown to support data transmission rates of up to and including 28.8 kilobits per second (Kbps).

The maximum data transmission rate is subject to the quality of the end-to-end channel and cannot be guaranteed.

Troubleshooting the device attached to the I-ATA

Check the following before you call a repair person:

- Check to see that the data parameters (for example, Parity or Baud Rate) are set correctly.
- Ensure that tones are turned off for the I-ATA using * 8 0 9 .
- Make sure you are dialing out on an intercom or external line. Use 2 to choose an alternate line. Contact your installer or customer service representative to change the prime line for the telephone or device.
- Substitute a single-line telephone for your data communication device. If you receive a dial tone on the single-line telephone, the problem might be with the data communication device.

ISDN

Integrated Services Digital Network (ISDN) technology provides a fast, accurate and reliable means of sending and receiving data, image text and voice information through the telephone system.

By using Basic Rate Interface (BRI), your ISDN service allows for faster transmission speeds and the addition of a variety of powerful business applications, including remote LAN access, videoconferencing, file transfer and Internet access.

Your installer configures your ISDN services and terminal equipment.

ISDN BRI

Compact ICS supports the following ISDN services:

- incoming calls
- outgoing calls
- Calling Line Identification Presentation (CLID)
- Sub-addressing
- bearer capabilities
- teleservices

The Call Forward All Calls feature can be used from ISDN terminals connected to Compact Plus.

Note: Norstar and Business Series Terminals (BST) telephones can accept voice calls only. Video and data calls do not alert at the telephones.

Although an ISDN S-loop or LT-loop can support up to eight devices, the loop has a limit of two B-channels. If both B-channels are in use, other devices on that loop cannot make or receive calls until a B-channel is available, or until both B-channels are available in the case of a video terminal. Thus, the number of terminals installed must take into account whether you require dedicated access for the terminals on that loop.

Note: System telephone features, other than Transfer and Call Forward All Calls, are not available to ISDN terminals. In addition, you cannot retrieve a parked call, or reach a Direct-Dial set by using the Direct-Dial digit from an ISDN terminal.

Line access from an ISDN terminal

ISDN terminals do not have line buttons or intercom buttons as do Norstar and BST telephones. To make an outgoing call from an ISDN terminal, access an external line by entering a line pool code or by using the ARS feature.

ISDN BRI features

Selected ISDN network features can be used from a Norstar telephone. Your central office switch (ISDN network) determines which features are available to you.

Network Name Display for BRI

Your Norstar system displays the name of an incoming call when it is available from the service provider. Name information can be displayed on a telephone but not on an ISDN terminal. If the Calling Party Name has the status of private, it may be displayed as Private name. If the Calling Party Name is unavailable, it may be displayed as Unknown name.

Your Norstar system displays the name of the called party on an outgoing call, when it is provided by your service provider.





Your Norstar system sends the Business Name concatenated with the telephone name on an outgoing call but only after the Business Name has been programmed.

The available features include:

- receiving connected name
- receiving calling name
- receiving redirected name
- sending connected name
- sending calling party name

Consult your customer service representative to determine whether or not this feature is compatible with your service provider.

Name and number blocking for BRI

When activated,     allows you to block the outgoing name and/or number on a per-call basis. Name and number blocking can be used with a Norstar set but not with an ISDN terminal.

Consult your customer service representative to determine whether or not this feature is compatible with your service provider.

Service provider features

Consult your customer service representative to determine if the new ISDN features are supported with your service provider.

Call Forward

Call Forward allows you to forward your calls to an external telephone number.

1. Select an ISDN line by selecting a line button, a line pool, or the handsfree button, or by lifting the handset (if an ISDN line is your prime line).
2. Consult your service provider for the appropriate feature code to enter on your dialpad. Listen for three tones followed by dial tone.
3. Enter the internal number of the telephone to which you want your calls forwarded. If the call is answered, stay on the line for at least five seconds to activate the Call Forward feature.

Canceling Call Forward

1. Select an ISDN line by selecting a line button, a line pool, or the handsfree button, or by lifting the handset (if an ISDN line is your prime line).
2. Consult your service provider for the appropriate feature code to enter on your dialpad. Listen for a series of tones.
3. Press .

Calling the number your calls are forwarded to

1. Select an ISDN line by selecting a line button, a line pool, or the handsfree button, or by lifting the handset (if an ISDN line is your prime line).
2. Consult your service provider for the appropriate feature code to enter on your dialpad.

Automatic Call Back

If you call a number that is busy, enter the feature code designated by your service provider to receive a distinctive ring at your set when the line becomes available for calls.

Automatic Recall

Automatic Recall allows you to automatically dial the number of the last call you received. You may not see the number on the display if the information is not available from your service provider, or you do not have Caller ID as part of your ISDN service.

Consult your service provider for the appropriate feature code to enter on your dialpad.

MCID (profile 2)

The MCID feature allows you to use to have call information recorded on the central office system for an incoming call on a specific line (EUROISDN lines, only).

The user must invoke the feature code either during the active call or within within 30 seconds (time varies on different networks) after the caller hangs up, but before the user hangs up.

MCID prompts

Call traced	The MCID request was accepted by the network.
No response	No response to the MCID request.
Not incoming	MCID can only be invoked on received calls.
Not available	The caller information is not available. The CO is not able to log the information or it is not an ETSI BRI type of call.
Not subscribed	MCID feature is not subscribed to.
Invalid state	MCID is not allowed in the current state of the call.
Not allowed	Invalid interaction with another supplementary service.

Network Call Diversion (profile 2)

This feature is a network function that allows forwarding and redirection of calls outside the Norstar network when using an ETSI ISDN line. Functionality is similar to that of External Call Forward (ECF). NCD redirects calls using the same line on which they arrive. Call forward is efficient since there is no need for additional outside lines.

ISDN BRI terminals

Your Compact ICS supports up to eight Basic Rate Access loops (four 2B+D channels) that can be used for fully digital connections to ISDN networks and devices. Loops are connections between the ICS and devices or between the ICS and the network.

Each loop provides two separate B-channels that can be used to make two simultaneous voice or data calls, or one data call and one voice call.

ISDN applications

ISDN terminal equipment delivers a wide range of powerful business applications:

- **Videoconferencing and video telephony:** Videoconferencing offers instant visual and audio contact between distant parties using either studio-based or desktop ISDN terminals.
- **Desktop conferencing:** ISDN allows computer users in distant locations to share and edit any image, data or text file on their own computer screens while they discuss the information.
- **File transfer:** The ISDN network allows you to transfer files containing data, text, images, data, or audio clips, faster and cheaper than with a conventional modem.
- **Telecommuting:** Convenient retrieval, processing and storage of files is possible for the employee working at home by using ISDN lines to give high-speed access to information resources at the office.
- **Group 4 fax:** ISDN fax applications save money by increasing both transmission speed and the quality of resolution.
- **Remote LAN access:** ISDN provides an affordable and fast means for employees at remote sites (at home or branch offices) to access local area networks (LANs).
- **Leased line backup:** Essential backup for leased lines can be provided using ISDN as required, rather than duplicating costly permanent leased lines.
- **LAN to LAN bridging:** Local area network (LAN) bridge/routers allow flexible interconnection between LANs using ISDN, with charges only incurred when information is actually transmitted.

- **Internet and database access:** The fast call set up and high bandwidth of ISDN are ideal for accessing information services such as the Internet and databases.

Using System features

Using alternate or scheduled services

There are three types of Services to make your Norstar system handle calls differently on different days and at different times of the day: Ringing service, Restriction service and Routing service.

Each of the three services, and the six schedules available to each service, are customized for you by your installer or customer service representative. They program which telephone is used to turn Services on and off, and display what Services are in use. This is called the control telephone.

Preventing certain calls from being made

Restriction service prevents a user from making certain kinds of calls from a telephone or from lines that are available at the telephone. The restrictions are programmed by your installer or customer service representative. For example, you might want to restrict long distance dialing between certain hours of the day.

Making additional telephones ring

Ringing service makes additional telephones ring for incoming calls on external lines. For instance, all incoming external calls can ring at a security telephone during the night, or calls to one attendant can ring at another attendant telephone during lunch. It does not suppress your normal ringing assignment.

Changing the lines used by outgoing calls

Routing service allows you to assign alternate routes to calls. In this way you can take advantage of lower costs available on particular routes on certain days and at certain times. Both the regular and alternate routes are programmed by your installer or customer service representative.

Note: Your system administrator can also assign alternate routes for destination codes that are defined to run on a schedule. In this case,

alternate routes are offered only in the case where the original route is not available. Refer to the section on least-cost routing in the *Compact ICS Installer Guide*.

Turning Services on and off

The master control for how different services and their schedules are used by your system is in programming. There are three settings: **Manual**, **Automatic** and **Off**.

- **Manual** allows you to turn the service on and off at any time from a control telephone using a feature code.
 - **Automatic** allows you to use the preassigned stop and start time for a service. You are able to start and stop the service by entering the appropriate feature code at a control telephone. If you select this setting, you use the start and stop times programmed by your installer or customer service representative.
 - **Off** prevents the service from being activated.
1. Place the programming template over the appropriate buttons of the programming telephone.
 2. Press * * 2 6 6 3 4 4 .
 3. Press 2 3 6 4 6 (the default System Coordinator password).
 4. Press twice.
 5. Press at **Services**.
 6. Press until you see the Service you want to program.
 7. Press and until you see the schedule you want to program.
 8. Press and use **CHANGE** to select the setting that works best for your office: **Off**, **Manual** or **Automatic**.

Each schedule can have its own configuration of a Service which works independently of automatic start and stop times. For example, there may be a version of Restriction service called Night Schedule that prevents anyone from making long distance calls. But calling it Night Schedule does not mean it can only be used with a schedule. You can turn the Night Schedule for Restriction Service on or off, as needed, any time of the day or night. If

you decide to run a service on a schedule, the system uses the start and stop times used for that schedule.

An example of how to turn on a Service manually

You may have Ringing service (your night service) set up to run according to the Night Schedule. You may decide you want that ringing arrangement to come into effect only when it is turned on and off manually.

1. Place the programming template over the appropriate buttons of the programming telephone.
2. Press .
3. Press (the default System Coordinator password).
4. Press twice. **SerVICES** displays
5. Press . **Ringing Service** displays.
6. Press . The display reads **Sched:Night**.
7. Press and use **CHANGE** to set the Service to **Manual**.

Night Schedule for Ringing Service no longer follows the schedule but can be turned on and off by using the feature code and selecting Night Ringing. See “Turning Services on and off using feature codes” on page 213.

Turning Services on and off using feature codes

The master control for services is in programming. See “Turning Services on and off” on page 212. Day-to-day use of Services is controlled using the following feature codes.

Turns on Ringing service. When used at the direct-dial telephone, it activates the alternate direct-dial telephone (extra-dial telephone).

To turn on a Service

1. Enter the appropriate feature code from a control telephone.
2. For Restriction and Routing service you have to enter the System Coordinator or Basic password.
3. Press **NEXT** to move through the schedules until the display shows the version of the service you want to be turned on.
4. Press **OK** to select the setting, or press **QUIT** to exit the feature without making any changes.

To turn off a Service

1. Enter the appropriate feature code from a control telephone.
2. For Restriction and Routing service you have to enter the System Coordinator or Basic password.



Do not confuse activating Normal service with canceling a Service.

Setting a Service to Normal is not the same as canceling a Service using a feature code. If you set the Service to Normal, the normal version of a Service overrides any automatic schedule and remains in effect until you manually cancel it. If you cancel the Service, you return to the automatic schedule.

Viewing the active Services from a two-line display telephone

When a Service is active, the control telephone display shows **Services ON**.

1. Press **LIST**. The display shows the first active Service and the schedule that is in use.
2. If there are several active Services, press **NEXT** to see them all.
3. Press **EXIT** to exit the feature.

Viewing the active Services from a one-line display telephone

1. Press . The first active Service displays.
2. Press to move through the active schedule.
3. Press to exit.

Displays

```
<Sched> Restr'n
EXIT          NEXT
```

You are viewing the active Services. Press or NEXT to see the other active Services. Press or EXIT to quit.

```
<Sched> Restr'n
QUIT   OK   NEXT
```

The name of the current Restriction service schedule is displayed. Press or NEXT to see the other Ringing service schedules. Press or OK to select the desired schedule.

```
<Sched> Ringing
EXIT          NEXT
```

You are viewing the active Services. Press or NEXT to see the other active Services. Press or EXIT to quit.

```
<Sched> Ringing
QUIT   OK   NEXT
```

The name of the current Ringing service schedule is displayed. Press or NEXT to see the other Ringing service schedules. Press or OK to select the desired schedule.

```
<Sched> Routing
EXIT          NEXT
```

You are viewing the active Services. Press or NEXT to see the other active Services. Press or EXIT to quit.

```
<Sched> Routing
QUIT   OK   NEXT
```

The name of the current Routing service schedule is displayed. Press or NEXT to see the other Routing service schedules. Press or OK to select the desired schedule.

```
<Sched> until *
QUIT   OK   NEXT
```

Press or OK to select this schedule, or NEXT to see the next available schedule, or or QUIT to exit. If you select this schedule, it is in effect until the next automatic schedule takes effect.

```
No services ON
```

You have entered the Show Services feature code and there is no active Service.

Services	ON
	LIST

There is a Service active in your system. Press or LIST to view the active Services.

For other displays, see “Common feature displays” on page 243.

Services that have been turned on automatically are indicated by an asterisk (*) before the name on the display. You can neither manually activate nor cancel automatically-scheduled services, although you can override them by manually turning on another schedule.

The control telephone can override Services that are turned on and off according to a schedule at any time by entering a Services feature code, and then by selecting a different schedule. This override remains in effect until it is canceled. If you select a schedule with an asterisk (*), the next automatic service schedule comes into effect at the programmed time.

Direct-dial calls to a direct-dial telephone ring at the extra-dial telephone (the extra-dial telephone is designated by your installer or customer service representative) only when you enter the Ringing service feature code (8 7 1) at that direct-dial telephone. Note that only the extra-dial telephone is activated, not the actual Ringing service (unless that direct-dial telephone is a control telephone).



Tip - *Norstar provides six service schedules named Night, Lunch, Evening, Sched 4, Sched 5, and Sched 6. Your installer or customer service representative can change these names to suit your business.*

Using passwords

Your passwords prevent unauthorized or unintentional changes to your Norstar system. To keep your telephone service secure, distribute the password only to selected personnel or make use of the basic password described below. Record your password in a secure place and change it periodically.

If you forget the administration or basic passwords, you cannot do any programming. Call your customer service representative to assign a new password.

The password is a one to six-digit number.

The default System Coordinator password is **A D M I N**, which is the same as **2 3 6 4 6**.

One password cannot be a subset of another one. For example, you cannot have 123 and 12345.

Using a Basic password

In addition to a System Coordinator password, there is a Basic password. This allows you to delegate some of the duties of being a system coordinator to someone else without allowing access to sensitive programming.

The default Basic password is **B A S I C** or **2 2 7 4 2**.

You can enter the Basic password after the following feature codes:

- *** * U S E R** (User Preferences)
- *** * T I M E** (to change the system time and date)
- *** 8 3 1** (turn System Answer on or off)
- *** 8 3 2** (turn Custom Call Routing on or off)

Because the Basic password can be used to change the time, you should give it out with care and change it when necessary (for example, when an employee leaves the company). If restrictions, routing or other services operate on a schedule, changing the time can allow someone to bypass the programming.

Changing passwords

1. Place the programming template over the appropriate buttons of the programming telephone.
2. Press * * 2 6 6 3 4 4 .
3. Press (the default System Coordinator password).
4. Press four times. **Passwords** displays.
5. Press . **Call Log Pswds** displays.
6. Press until you see **Programing Pswds ▶**.
7. Press . **Sys Admin:** displays.
8. Press until you see the name of the password you want to change.
9. Use , **CHANGE** and the dialpad to enter the new password. Press **OK** to accept the new password.

You cannot erase or eliminate the ability to program passwords.

Clearing a Call Log password

If an individual has forgotten their Call Log password, you can clear it in programming. The individual can then enter a new password from his or her telephone.

1. Place the programming template over the appropriate buttons of the programming telephone.
2. Press * * 2 6 6 3 4 4 .
3. Press (the default System Coordinator password).
4. Press four times. **Passwords** displays.
5. Press . **Call Log Pswds** displays.
6. Press until the display shows **Call log Pswds**.
7. Press and enter the internal telephone number of the telephone where you want to clear the Call Log password.
8. Press , then press **CLR** to clear the password.

Hospitality passwords

There are two passwords within the Hospitality feature. One provides secure access to the administration set for programming the service, and one provides secure access to a room condition setting from each room set for housekeeping staff.

Desk pswd

Change this password frequently, to maintain security.

At Hospitality:

1. Press . **Desk Pswd:** displays. (default is 4677)
2. Press **CHANGE**. **New Pswd:** displays
3. Enter a new password, then press **OK**.

Cond pswd

Change this password frequently, to maintain security.

At Hospitality:

1. Press . **Desk Pswd:** displays.
2. Press . **Cond Pswd:None** displays.
3. Press **CHANGE**. **New Pswd:** displays
4. Enter a new password, then press **OK**.

Silent Monitor password

Users must enter a password when they use to monitor Hunt group calls.

It is advisable to change this password frequently.

At Hospitality:

1. Press . **SM Pswd:** displays. (default: SILENT)
2. Press **CHANGE**. **New Pswd:** displays
3. Use the keypad to enter a new password.
4. Press **OK**.

Using special telephones

Direct-dial

You can reach the direct-dial telephone by dialing a single digit. The direct-dial telephone is usually in a central location, such as a attendant's desk. It is usually the prime telephone or the central answering position (CAP).

The direct-dial telephone can send up to 30 messages and can invoke Services to activate the extra-dial telephone.

You cannot forward calls to a direct-dial telephone that is outside your Norstar system. See “Making changes to Call Forward No Answer” on page 35.

Note: ISDN terminals cannot use the Direct-Dial digit to reach a Direct-Dial set.

Changing the direct-dial telephone assignments

Your installer or customer service representative sets up the direct-dial telephone.

You can change which direct-dial telephone a telephone is assigned to, or assign it no direct-dial telephone.

1. Place the programming template over the appropriate buttons of the programming telephone.
2. Press * * 2 6 6 3 4 4 .
3. Press (the default System Coordinator password).
4. Press at **Terminals&Sets**.
5. Enter the internal number of the telephone you want to program and press . The display shows **Capabilities**.
6. Press .
7. Press until the display shows **D-Dial**.
8. Press **CHANGE** to select either **Set1** or **None**.

Any number of telephones can be assigned to call the direct-dial telephone.



Tip - *The digit you dial in order to get the direct-dial telephone to ring can be programmed by your installer or customer service representative*

Hotline

A hotline telephone calls a preset internal or external telephone number when you pick up the handset (or press the handsfree button).



Tip - *Label the telephone to inform anyone using it that Hotline is active.*

Bypassing a Hotline

Press a line button, or use the Pre-Dial or Automatic Dial feature before you pick up the handset or press the handsfree button on a hotline telephone. See the *Telephone Feature Card* or see “Changing how you dial your calls” on page 75.

Making a telephone a hotline telephone

You can set up a telephone as a hotline.



Tip - *A Hunt Group set DN can be specified as a Hotline telephone. For more information about Hunt Groups, see “Programming Hunt Groups” on page 165.*

1. Place the programming template over the appropriate buttons of the programming telephone.
2. Press * * 2 6 6 3 4 4 .
3. Press (the default System Coordinator password).

4. Press at **Terminals&Sets**.
5. Enter the internal number of the telephone.
6. Press . The display shows **Capabilities**.
7. Press .
8. Press until the display shows **Hotline**.
9. Press **CHANGE** to select the type of call the hotline makes: **None**, **Intrnl**, or **Extrnl**.

Internal assigns an internal number.

External assigns an external number. If you select an external number, you can select the line on which the call is made:

- the prime line
- an external line
- a line in a line pool, and a line pool access code
For this type of line, you must specify the line pool access code.
- a line selected by the routing table
For this type of line, the number dialed is treated as a destination code and is routed according to the routing tables.

A telephone prime line, line pool access codes, and access to a line pool can be programmed by your installer or customer service representative.

Control telephone

The control telephone allows you to place the telephones and external lines for which it has responsibility into and out of service schedules. See “Using alternate or scheduled services” on page 211.

SM Supervisor

A telephone designated as an SM Supervisor allows you to monitor Hunt group calls without or without a conference tone indicator to the other two parties. See “Using Silent Monitor” on page 174.

Using Set lock

Set lock limits the ways in which you can customize your telephone. There are three levels of Set Lock: **Full**, **Partial**, and **None** (no set lock). With no set lock, you have access to all features on your telephone.

Partial prevents:

- | | |
|--|---|
| <ul style="list-style-type: none"> • programming autodial buttons • programming user speed dial numbers • programming feature buttons • moving line buttons • changing the display language | <ul style="list-style-type: none"> • changing dialing modes (Automatic Dial, Pre-Dial, and Standard Dial) • using Voice Call Deny • saving a number with Saved Number Redial |
|--|---|

Full, in addition to the restrictions outlined for Partial lock, prevents:

- | | |
|--|---|
| <ul style="list-style-type: none"> • changing Background Music • changing Privacy • changing Do Not Disturb • using Ring Again | <ul style="list-style-type: none"> • using Call Forward all calls • using Send Message • using Trunk Answer • activating Services |
|--|---|

Changing Set Lock programming for a telephone

1. Place the programming template over the appropriate buttons of the programming telephone.
2. Press * * 2 6 6 3 4 4 .
3. Press (the default System Coordinator password).
4. Press at **Terminals&Sets** and enter the internal number of the telephone you want to program.
5. Press .
6. Press until the display shows **Restrictions**.
7. Press twice.
8. Use **CHANGE** to select one of the three options: **None**, **Partial** and **Full**.

The Link signal can be included as part of a longer stored sequence on an external autodial button or in a speed dial code. The Link symbol (■) uses two of the 24 spaces in a dialing sequence.

Preventing a telephone from using Link

Link can be restricted at individual telephones.

1. Place the programming template over the appropriate buttons of the programming telephone.
2. Press * * 2 6 6 3 4 4 .
3. Press (the default System Coordinator password).
4. Press and enter the internal number of the telephone you want to program.
5. Press .
6. Press three times. The display shows **Restrictions**.
7. Press twice.
8. Press three times. The display shows **Allow link:**.
9. Press **CHANGE** to choose **Y** (Yes) or **N** (No).



Tip - If your Norstar system is connected to a private branch exchange (PBX), program Link onto a memory button for one-touch access.

Pause

7 8

The Pause feature enters a 1.5-second delay in a dialing sequence on an external line. This is often required for signaling remote devices, such as answering machines, or when reaching through to PBX features or host systems.

You can program more than one pause in an external autodial or speed dial sequence.





The Pause symbol (⏸) uses one of the 24 spaces in a dialing sequence.

For pulse dialing,  inserts a 1.5-second pause into the dialing sequence.

Long Tones

The Long Tones feature allows you to control the length of a tone so that you can signal devices such as fax or answering machines which require tones longer than the standard 120 milliseconds.



1. While on a call, press    .
2. Press the dialpad buttons to produce the appropriate tones. Each tone sounds for as long as you hold down the button.

Long tones can be used on any call except a conference call. You can use internal lines of the Norstar system to activate a device connected to an analog terminal adapter (ATA) in another area of your office, or external lines to access devices outside the Norstar system.





Digital Mobility phones provide a static three-second DTMF tone when this feature is activated.

Displays

Long Tones:

At the appropriate time, press any dialpad button. Hold each button down for as long as necessary. Press  or  to cancel Long Tones.

Programmed Release

The Programmed Release feature performs same function as  in a programmed dialing sequence. When the system encounters Programmed Release in a dialing sequence, it stops dialing and hangs up the call.

The Programmed Release symbol () takes up two of the 24 spaces in a programmed dialing sequence.

The system ignores any digits or commands that follow a Programmed Release in a programmed dialing sequence.

Run/Stop



Run/Stop inserts a break point into a sequence of dialed numbers or characters used for automatic dialing. This may be necessary when you are connecting to a PBX or similar host system.

For example, you can call a company with an automated attendant that instructs you to dial the internal number you need. You can program the company number, a Run/Stop, then the internal number on one external autodial button. Press the autodial button once to dial the company number. When you hear the automated attendant, press the autodial button again to dial the internal number.

The Run/Stop symbol () uses one of the 24 spaces in an autodial or speed dial sequence.

You can include up to three Run/Stop commands in a dialing string. The system ignores a fourth Run/Stop, and any digits or commands that follow it in a programmed dialing sequence.

Wait for Dial Tone



Wait for Dial Tone causes a sequence of numbers to pause until dial tone is present on the line before continuing to dial. This is useful if you must dial a remote system and then wait for dial tone from that system before dialing the rest of your number.

The Wait for Dial Tone symbol () uses two of the 24 spaces in an autodial or speed dial sequence.

Displays

`Invalid code`

You have entered a code that can only be used in a programmed autodial or speed dial sequence, not on a call you dial directly. Programmed Release and Run/Stop are for use in programmed dialing sequences only.

Using tone dialing for a call

If your external telephone lines use tone dialing, you can temporarily switch to tone dialing by pressing **#** after selecting the line. Tone dialing allows your Norstar telephone to communicate with devices and services that respond to tone signals, such as automatic switchboards, and fax or answering machines.

Using your Norstar system from an external location

You can use the lines and some of the features of a Norstar system from outside the system. You can do this over the public telephone network when you are away from the office, or you can call from another system, over a private network.

An example of how remote access works is a sales representative who spends a lot of time out of the office and who needs to make long distance calls to the European office. Your Norstar system has a leased line to Europe with reduced transatlantic charges. You provide that sales representative with a Class of Service (COS) password that gives access to the transatlantic line. The sales representative can then telephone into the Norstar system from a hotel, enter their Class of Service password, and use the leased transatlantic line to make calls.

Remote users can access Norstar lines, line pools, the page feature, and remote administration (if enabled through Software Keys). The exact facilities available to you through remote access vary, depending on how your installer or customer service representative set up your system.

Controlling access to your Norstar system

It is important to maintain the security of your Norstar system by limiting access to authorized users and limiting those users to the features they need.



Remote users can make long distance calls.

Remember, a remote user can make long distance calls that are charged to your company and can make page announcements in your office unless you create the proper restrictions for external access lines.

Direct inward system access (DISA)

Control access to your Norstar system with direct inward system access (DISA). Access to your Norstar system from the public telephone network should always be controlled with DISA. If your installer or customer service representative programs the line used for remote access to answer a call automatically and wait for a DISA internal number, callers hear a stuttered dial tone and must enter a Class of Service password before they are allowed into the system.

Class of Service (COS)

To control the level of telephone service a remote user can access, your installer can assign a remote filter and remote package to the line used for remote access. The remote filter restricts the numbers that can be dialed on the line, and the remote package restricts the use of line pools and the page feature. To change the restrictions for the line, the user can enter their Class of Service (COS) password when the system answers with DISA, or can dial the DISA internal number and enter their Class of Service password.

Maintaining security

To maintain the security of your system, the following practices are recommended:

- Warn anyone to whom you give the remote access number to keep it confidential.
- Change Class of Service passwords often.
- Warn anyone to whom you give a Class of Service password to remember it and not to write it down.
- Remove the Class of Service password of anyone who leaves your company.

Accessing Norstar remotely over the public network

1. Dial the Norstar system remote access number.
2. When you hear a stuttered dial tone, enter your COS password.
3. Wait for the system dial tone.

If your system uses System Answer or CCR, you may enter the DISA number or Auto DN once your call has been automatically answered by one of the features.

To use the system remotely, you must use a telephone with tone dialing to call the system.

Remote access is possible only on lines that your installer or customer service representative programs to allow auto-answer calls.

To use features on a remote Norstar system, press followed by the feature code. Even if you are calling from a Norstar system, press instead of .

In certain situations, you may experience lower volume levels when using Norstar remotely.

Tones

You may hear some of the following tones while accessing Norstar remotely.

Tone	What it means
Busy tone	Dialed a busy line pool access code. You hear system dial tone again after five seconds.
Stuttered dial tone	Enter your COS password.
Norstar system dial tone	You may use the Norstar remotely.
Fast busy tone	<p>You have done one of the following</p> <ul style="list-style-type: none"> • Entered an incorrect COS password. Your call is disconnected after five seconds. • Taken too long while entering a COS password. Your call is disconnected after five seconds. • Tried to use a line pool or feature not permitted by your Class of Service. You hear system dial tone again after five seconds. • Dialed a number in the Norstar system which does not exist. Your call is disconnected after five seconds.

Using Class of Service (COS) passwords

Class of Service passwords permit controlled access to system resources both by internal and remote users. When you enter a Class of Service password at a telephone, the restriction filters associated with your Class of Service password apply, rather than the normal restriction filters.

Similarly, when a remote user enters a Class of Service password on an incoming auto-answer line, the restriction filters and remote package associated with their Class of Service password apply, rather than the normal restriction filters and remote package. COS passwords are programmed by either your customer service representative or installer.

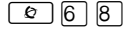

Users should memorize their COS passwords instead of writing them down. Employee COS passwords should be deleted when they leave the company. Typically, each user has a separate password. Several users can share a password or one user can have several passwords.

Changing your Class of Service



You must enter a Class of Service password each time you want to make a call that is normally restricted on a line or telephone.

To change the restriction filters on a line or telephone:

1. Press   .
2. Enter your six-digit COS password.

COS passwords allow you to define individual passwords and determine the restriction filters, and remote package associated with each.



Tip - *If you use your Norstar system from outside the office, you may have to enter a Class of Service password to gain access to the system. See “Using your Norstar system from an external location” on page 228.*

Displays



(Blank display) Enter your password. It is not shown on the display.

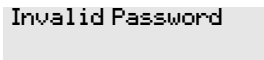

You have entered a password that is not programmed into your system.

General System features

The following features are available for the entire Norstar system.

Disconnect supervision

When Disconnect Supervision is assigned to a line, the Norstar system monitors it to detect if an external caller hangs up. This allows the system to release the line for other uses. Your installer or customer service representative assigns disconnect supervision.

Hunt Groups



Your Norstar system allows you to establish Hunt Groups. Hunt Groups are a group of system digital phones which can be called by a single directory number. The Hunt Groups feature ensures calls are easily routed to the appropriate people.

You can also monitor hunt group calls using the Silent Monitoring feature. The Digital Mobility phone, however, cannot be used to as a supervisor set, although it can be assigned as a hunt group member.

For more information about Hunt Groups see “Programming Hunt Groups” on page 165.

Internal numbers

Each telephone in the Norstar system has its own internal number. The length of internal numbers in your system can be from two to seven digits. All numbers in your system are the same length. Your installer or customer service representative sets the length of internal numbers (called the DN length).

To find out your internal number, use the Button Inquiry feature (  ) on an intercom button. On the 7100 telephones and the Digital Mobility phones, Button Inquiry shows your internal number. Note that on the Digital Mobility phones this display only lasts for three seconds.

Line assignment

Any of the lines in your system can be assigned to any of your telephones. Your installer or customer service representative assigns lines to telephones in **Configuration** programming. Lines can be assigned to appear only, appear and ring, or to ring only.

Usually, only the lines that are appropriate for a particular person appear at that person's telephone. When a line is assigned to a telephone it is automatically given a line button on that telephone, if a button is available.

Calls on lines that ring but do not appear at a telephone are presented at an intercom button.

The 7000 and 7100 digital phones and Digital Mobility phones do not have line buttons or visible intercom buttons. Calls assigned to these telephones must be set to Ring only.

You may be able to answer a call on a line that does not appear or ring at your telephone. To pick up such a call, use Call Pickup, Call Park, or Trunk Answer.

A telephone may have buttons assigned for lines 001 to 003, but have only lines 001 and 002 programmed to ring as well. An incoming call on any of the three lines causes a line button indicator to flash, and the telephone can be used to answer the call. This is especially useful for people who monitor other telephone lines, but want only their own lines to ring.

Target line

A target line is used to route a call directly to a particular telephone or group of telephones.

Target lines (061-086) are used only for incoming calls and appear on the Intercom button. A single incoming line may provide connections to several different target lines. This allows each person or department in the office to have their own number without having a separate external line for each number.

Note: Although target lines can be set to Private (default is Public), features such as Call Pickup can still answer these calls at remote telephones.

Line pools

A line pool allows each telephone access to external lines from a group (or pool) of external lines. You can access such lines by pressing an intercom button and entering a line pool access code, a destination code that uses that line pool, or by pressing a memory button programmed with the line pool feature code and a line pool access code.

Overflow call routing

If a call comes in for a target line that is busy, Norstar routes the call to the prime telephone for that target line. If there is no prime telephone assigned to the target line or if a call cannot be directed to a target line, the call goes to the prime telephone for the external line used.

Overflow routing for incoming calls is used with the Routing Service programmed by your installer. A Service must be active for overflow routing to be in effect. Overflow routing is not available in normal service.



Tips - *When you make a call and the programmed route is busy, you hear the expensive route warning tone. Your telephones displays an expensive route warning. To avoid using the normal, expensive route, release your call.*

Overflow routing directs calls using different line pools. Therefore, a call may be affected by different line filters when it is handled by overflow routing.

Telephones with no line buttons

The 7000 and 7100 digital phones and the Digital Mobility phone do not have line buttons, therefore, they work differently from other Norstar telephones.

- Where other telephones can require that you select a line button to answer a call, on these telephones you simply pick up the receiver.
- Where other telephones require you to select a line button to take a call off hold, you press the Hold button.

- Also on these sets, you can answer a second call by pressing the Hold button. Your active call is put on hold and you are connected to the waiting call. You can have no more than two calls at a time.

There is no handsfree button on these telephones. When applicable, special instructions for the telephones are included with each feature description.

Memory buttons

Memory buttons are the buttons beside the main dialpad on the digital telephones. Some telephones have two rows of memory buttons, others have only one row. The 7100 digital phone has only one memory button.

Memory buttons can be used as answer DN, autodial, line, and programmed feature buttons. Line, intercom and answer DN buttons must have indicators and are programmed by the system administrator.

Key Indicator Modules (KIMs) that attach to 7316E telephones support 12 memory buttons per module. If the 7316E+KIM is configured as an enhanced CAP (eCAP), besides programming features to the KIM buttons, you can also move line appearances, multiple target line appearances and hunt group appearances to the KIM.

One-line display









The 7100 and 7208 digital phones have a one-line display.

Other telephones have a second line on the display, which shows the functions of the three buttons directly below it. These indicators are known as display buttons.

Some display buttons, such as TRANSFER and ALL, are simply shortcuts which are not available on a one-line display.

Other display buttons, such as OK and SHOW, perform essential functions. For a one-line display telephone, use the following buttons instead of these display buttons.

Substitutes for display buttons

Display button	Dialpad button	Display button	Dialpad button
<u>OK</u>		<u>CANCEL</u>	
<u>QUIT</u>		<u>VIEW</u>	
<u>ADD</u>		<u>OVERRIDE</u>	
<u>SHOW</u>		<u>BKSP</u>	

All displays listed in this book are shown as they appear on the two-line display.

Prime line

Your telephone can be programmed to select an internal or external line or a line pool automatically whenever you lift the handset or press the handsfree button. This is your prime line.

Private lines

A private line is exclusive to a particular telephone. Calls that are put on hold or left unanswered on a private line cannot be picked up at any telephone except the prime telephone.

Volume bar

The volume bar controls the volume of the handset, telephone ringer, handsfree speaker, and headset. Press either end of the volume bar

 to adjust the volume.

Troubleshooting

Using the alarm telephone

An alarm telephone displays Norstar system alarm codes, should they occur. Alarm telephones are Norstar system digital phones with two-line displays that are specifically assigned by the installer to receive system alarm codes.

Reporting and recording alarm codes

If an alarm message appears on the alarm telephone display

1. Record the alarm number.
2. Press **TIME** and record the time displayed.
3. Call your installer or customer service representative and report the alarm code.
4. After speaking to your installer or customer service representative, press **CLEAR**.

Displays

Alarm:	61-4-2
TIME	CLEAR

Report this alarm and the time it occurred to your installer or customer service representative.

Testing the telephone

If you suspect something is wrong with a button, the speaker, the displays, or some other part of the telephone hardware, you can do a quick test to see which part of the telephone is broken.





Tip - Ensure that the function of a button matches the label by pressing **[hook]** **[*]** **[0]** then the button.

You can end the telephone testing session anytime by pressing **[hook]** or **[hook]**, unless you are testing those buttons. The test feature times-out after 30 minutes of no activity.

Digital mobility phones do not use the following procedures. They may have internal tests. Refer to the user card that came with the handset.

Testing the telephone display





Use a display test if you suspect that one of the indicators on the telephone is not working.

1. Press  8 0 5. The display shows **Display test**.
2. Press **TEST** or  to go ahead with a display test.
3. Adjust the contrast for the telephone display so you are able to see the test results clearly. Enter a number to change the contrast or press **DOWN** and **UP**.
4. Press **OK** or  to go ahead with the test.

During the test, the display should be filled with solid, dark blocks and all the indicators next to the buttons on the telephone should be turned on. Attachments, such as Key Indicator Modules (KIMs) that are attached to the telephone should be completely lit. You lose any information that was showing on the display before the test started.

Pressing any button ends the test.

Testing the telephone buttons

1. Press  8 0 5, then  or **NEXT**.
2. Press **TEST** or  to go ahead with a button test.
3. Press button to see its function. If the button you pressed uses an indicator, it should turn on when you test the button.
4. Pressing the  button puts **RLS button** on the display briefly and returns you to the **Button test** display.

Testing the speaker in the telephone handset

The handset test is not available if you have a headset plugged into the telephone.

1. Press **[☎] [8] [0] [5]**, then **[#]** or **NEXT** twice. The display shows **Handset test.**
2. Press **TEST** or **[☎]** to go ahead with a handset test.
3. Pick up the handset and listen. You should hear dial tone through the handset at a maximum volume. The volume is reset to maximum only while the test is going on.

Pressing any button or hanging up ends the test.

Testing the telephone headset

The headset test is not available to telephones that do not have a headset jack or a headset plugged in.

1. Press **[☎] [8] [0] [5]**, then **[#]** or **NEXT** until the display shows **Headset test.**
2. Press **TEST** or **[☎]** to go ahead with a headset test.

You should hear dial tone through the headset. The volume is reset to a default level during the test. Pressing any button ends the test.







Testing the telephone speaker

1. Press **[☎] [8] [0] [5]**, then **[#]** or **NEXT** until the display shows **Speaker test.**
2. Press **TEST** or **[☎]** to go ahead with a speaker test.

You should hear page tone through the telephone speaker at the maximum volume. The volume returns to its previous setting when you end the test.

Pressing any button ends the test.

Testing the power supply to a telephone

1. Press    , then  or **NEXT** until the display shows **Power test**.
2. Press **TEST** or  to go ahead with a power supply test.

You should see all the indicators on the telephone go on and hear ringing at maximum volume. When the test has ended, the display should briefly show **Power OK**.

The test lasts for five seconds or until you press a button.

Common feature displays

You may see the following displays when you use a feature.

Access denied

Someone is already using programming, or the feature you are trying to use is not compatible with the configuration of the telephone or line.

Denied in admin

You have tried to use a feature, but you have not been given access to it in administration programming.

Feature timeout.

You have taken more than 15 seconds to press a button in response to a display.

Inactive feature

You have entered a feature code that is used by an application program that your system does not have.

Invalid code

You have entered an invalid feature code.

Not available

You have tried to use a feature that is not available in the present setup of your Norstar system.

Set locked

You cannot use the feature you have chosen because your telephone is locked. See “Using Set lock” on page 223.

1234567890123...
VIEW→ OK

Press **#** or press VIEW→ or +VIEW to view a number that is too long to fit on the display. Press **☎** or OK when you are finished.

5

This indicates a long distance call. (May be available with Call Display services.)

39>21

Either you are receiving an internal call from telephone 39 forwarded by telephone 21 or you have an Answer button for telephone 21 and an internal call from 39 is ringing on 21.

21

TRANSFER

You are connected to an internal call. Press TRANSFER to transfer the call.

21 calling

You are receiving a call from telephone 21.

Call 21?
YES NO

You have received a Ring Again offer for a call to an internal telephone. Press the flashing internal line button or YES to call the number again. On 7000 and 7100 digital phones, just lift the handset. Otherwise, press NO or wait 30 seconds for the Ring Again offer to expire. For an explanation of Ring Again, see "Using Ring Again" on page 79.

Camped: 21
CALLBACK

The person to whom you camped the call did not answer it. The call has come back to you. Press the line button or CALLBACK to reconnect to the call.

Line001
TRANSFER

You are connected to an external call. Press TRANSFER to transfer the call.

Line001>21

Either you are receiving an external call forwarded from telephone 21 or you have an answer button for telephone 21 and an external call is ringing on that telephone.

Line001 transfer

The call on line 001 is being transferred to you by someone else in your Norstar system.

Line001 waiting

A camped call is waiting. Press the line button or use Call Queuing to answer the call. Press the Hold button if you have 7000 or 7100 digital phones or Digital Mobility phones.

No calls waiting

You tried to use Call Queuing but no call was ringing at your telephone.

No line selected

There is no call ringing at your telephone. If you have a flashing line button but your telephone is not ringing, press the line button to answer the call on that line.

Not in service

The telephone to which you directed a call is not in service or is otherwise unavailable. The call is returned to your telephone.

Parked call
CALLBACK

No one answered the call you parked. The call has come back to you.

Pick up receiver

You have used the Call Queuing feature without picking up the handset. Auto handsfree has not been assigned to your telephone. You must use the handset or the button labeled handsfree/mute to answer a call.

Priority> 21
BLOCK

You are receiving a priority call. If you are on another call, inform the person you are speaking to that the call is about to be put on hold. Press the flashing line indicator of the priority call or wait until the call connects automatically (in eight seconds). The priority call goes through when you hear the next beep. Your active call is placed on Exclusive Hold. It is reconnected automatically when the priority call ends (unless you transfer the priority call, in which case you must press the line button of your original call to reconnect). Use DND (8 5) or press **BLOCK** to reject a priority call.

Release a call

You have no free line buttons on which to receive a call. Release one of your current calls and try again to answer the incoming call.

Use line pool?
YES NO

You have received a Ring Again offer for a line pool. Press the flashing internal line button or **YES** to use the line pool. On 7000 and 7100 digital phones, just lift the handset. Otherwise, press **NO** or wait 30 seconds for the Ring Again offer to expire.

Hold or release

You cannot program a feature button while you are on a call.

Release calls

You have tried to use a feature while you were on a call or had calls on hold. Release the call or calls, before using the feature.

Line in use

The line is in use. Make the call using normal methods or wait until the line is free.

No button free

You have tried to make, receive or pick up a call when no line button was available. Some features require you to have a button free. Releasing calls can free up line buttons.

Make calls first

The feature you tried to use requires you to be on an active call at your telephone. This display also appears when information about a call has been cleared by a system reset.

No free lines

All the lines or line pools available to the telephone are in use. This display also appears when you have tried to dial an external number or use a feature that conflicts with the lines, line pools or prime line used by the telephone. This must be corrected by your customer service representative or installer.

No line selected

The telephone has been set up to dial an external number on a prime line but the telephone does not have a prime line. This must be corrected by your customer service representative or installer.

In use:21



You have tried to program redirection while someone else is programming redirection. Only one person can program line redirection at a time.

Incoming only

The line you are trying to use for redirecting calls is for incoming calls only. Choose an outgoing line.

9_

QUIT BKSP OK

Continue entering digits. Press  or  or BKSP to delete incorrect digits. Press  or OK when you are finished.

Invalid number

You have entered an invalid line pool code or an invalid destination code.

Line denied

You have selected a line that is private to another telephone.

Restricted call

The destination you have chosen for line redirection is restricted.

Index

Symbols

5 Long Distance symbol 243

6

Autobumping

canceling #815 139

using 815 139

autodial button

external *1 95, 97

internal *2 95

Background Music

canceling #86 194

turning on 86 194

Button Inquiry *0 101, 145,
233, 239

Call Duration Timer 77 69

Call Forward

canceling #4 115

using 4 115

Call Information 811 51, 52

Call Log

entering 812 141

external calls 813 139

options *84 138

password *85 141

viewing 812 139

Call Park 7 4 111

Call Pickup 76 54

Call Queuing 801 105

Call Transfer

canceling #70 108, 109

using 7 0 61, 107

Camp-on 82 110

Class of Service 68 232

Conference Call

7100 telephone #3 59, 60

using 3 58, 59, 60

using 3 58

Contrast Adjustment * 7 146

Custom Call Routing *832
85, 217

Dialing Modes *82 75

Directed Pickup 76 54

Do Not Disturb

canceling #85 193

turning on 85 77, 193

Exclusive Hold 79 104

Feature Button

erasing *1 147

programming *3 147

Group Listening

canceling #802 62

using 802 62

Hide message display 806
158

Host System Dialing Signals

Link 71 224

Long Tones 808 226

Pause 78 225

Programmed Release
*89 226

Run/Stop *9 227

Wait for Dial Tone 804
227

Language

English * 5 0 1 146

French * 5 0 2 146

Spanish * 5 0 3 146

Last Number Redial 5 97

Line Button, moving *81 156

Line Pool Access 6 4 74

Line Redirection

canceling #84 120

- using 84 120
- Message
 - canceling # 1 129
 - sending (1) 129
 - sending 1 128
 - viewing ones you sent 1 132
 - viewing 6 5 129
- Page
 - combined zone 6 3 125
 - external zone 6 2 125
 - internal zone 6 1 125
 - using 6 0 111, 113, 125
- Password
 - Basic B A S I C 27, 217
 - Call Log *85 141
 - System
 - Coordinator A D M I N 25, 27, 29, 32, 33, 34, 35, 36, 37, 38, 39, 217
- Password, Call Log *85 141
- Priority Call 6 9 78
- Privacy 83 68
- Ring Again
 - canceling # 2 79
 - using 2 79
- Ring Type * 6 157
- Ring Volume *80 157
- Ringing Service
 - turning on 871 213
- Saved Number Redial 6 7 101
- Services, viewing 870 215
- Speed Dial
 - adding user * 4 99
 - making calls 0 101
- Static Time and Date 806 132
- System Answer *831 84, 217
- System Answer, Custom Call Routing, recording a greeting *833 92, 94
- Testing
 - display 805 240
 - power supply 805 242
 - telephone buttons 805 240
 - telephone handset 805 241
 - telephone headset 805 241
 - telephone speaker 805 241
- Time and Date **8463 217
- Time and
 - Date * * T I M E 27
- Trunk Answer 800 56
- User Preferences * * U S E R 159, 217
- Voice Call Deny
 - canceling #88 134
 - using 88 134
- Voice Call 6 6 133
- ■ Link symbol 225
- ⚙ Pause symbol 225
- ■ Programmed Release symbol 226
- ■ Run/Stop symbol 227
- ■ Wait for Dial Tone symbol 227
- Numerics**
- 7100
 - line assignment 234
- 7100 sets
 - Line Redirection 119

- 7100 telephone
 - Hold many calls 103
 - Incoming Line Group button 42
 - standard dial 76
- 7208
 - button defaults 154
- 7316
 - button defaults 150
- 7316E
 - CAP 46
- A**
- access
 - Class of Service 231
 - external lines 235
 - Norstar from outside the system 228
 - remote 230
 - using a COS 229
 - using a DISA 229
- Access denied 243
- ADD 237
- adjusting the display 146
- administration password (see System Coordinator password)
- administration programming 16
- Alarm 61-4-2 239
- alarm codes
 - reporting and recording 239
- alarm telephone 239
- Allow calls 193
- allow redirect
 - programming 121
- Already joined 55, 71
- Already parked 113
- Alternate line (ATA feature code) 195
- alternate services 211
- analog telephone
 - answering a message 129
 - removing a message 131
 - replying to a message 130
- analog terminal adapter
 - dialing signals 226
 - using dialing modes 76
- analog terminal adapter, internal and features 195
- feature codes 200
- troubleshooting 201
- announcement
 - paging 125
 - Voice Call 133
- answer button
 - assigning to sets 155
 - type 57
- answer DNs
 - answer key 57
- answering calls
 - Answer DNs 57
 - Call Display services 50
 - Call Duration Timer 69
 - Call Pickup 54
 - CAP 46
 - Conference Calls 58
 - Custom Call Routing 82
 - distinctive ring patterns 44
 - Group Listening 62
 - Handsfree 63
 - hearing aid compatibility 50
 - prime telephone 44
 - Privacy 68
 - System Answer 81
 - Trunk Answer 56
 - using line buttons 42
 - using SWCA keys 105
 - using the Release button 50
 - Voice Call 134

- answering machine, and I-ATA
 - 200–201
- apply button cap labels 149
- ATA (see analog terminal adaptor)
- attendant telephone 85
- Auto Attendant 81–95
- Auto Call information (see Caller ID set)
- Auto System Answer (see System Answer)
- autodial
 - button inquiry 145
 - line selection 96
 - programming 95
 - storing number on a memory button 95
 - using Last Number Redial 98
- Autodial full 96
- automatic
 - Call information 52
 - Call Log 137
 - dial 76
 - Handsfree 66
 - release of a line (see Disconnect Supervision)
- Automatic Call Back, ISDN
 - terminal feature 206
- Automatic Recall
 - ISDN terminal feature 206
- Automatic Telephone Relocation 192, 233
- auxiliary ringer 224
 - Hunt Groups 172
- B**
- Back 22
- Background Music 194
- basic
 - answer button 57
 - Basic password 16, 159, 217
 - BKSP** 237
 - blocking
 - calls, see Do Not Disturb and DND
 - Business Series Terminals
 - wall mounting sets 190
 - busy
 - CLID display for incoming call 51
 - busy 71, 79
 - busy tone
 - fast 231
 - button cap labels
 - applying 149
 - button defaults
 - 7100 154
 - 7208 154
 - 7316 digital phone 150
 - 7316 telephone 152
 - Button erased 96
 - Button Inquiry 145
 - buttons
 - Answer DN/answer key 57
 - assign handsfree and mute 66
 - Button Inquiry 145
 - CAP 49
 - changing button
 - programming 160
 - default assignment 150
 - display 19, 20
 - eKIM 49
 - erasing programmed
 - features 147
 - Feature 19
 - Hold 19
 - Last Number Redial 97

- memory 19, 95, 236
 - moving line 156
 - numbering on all telephone types 160
 - programming features on
 - buttons 147
 - Release 19, 50
 - Saved Number Redial 101
 - testing 239, 240
 - using a line button 73
 - using buttons 17
 - volume control 19
- bypassing
 - a Hotline telephone 221
- C**
- call
 - ways to make a 71
- Call 221? 244
- Call blocked 78
- Call Display information 51
- Call Duration Timer 69
- Call Forward
 - ATA feature code 196
 - Call Forward No Answer 35
 - Call Forward on Busy 37, 117
 - Forward no answer 117
 - forwarding to voice mail 119
 - ISDN terminal feature 205
 - overriding 116
 - programming 35, 117
- Call Forward and Line
 - Redirection, differences 123
- Call information
 - automatic 52
 - changing what information is shown first 53
 - displaying information 50
 - getting information for a call on hold 52
 - getting information for a current call 52
- Call Log 137
 - Autobumping 139
 - automatic 137
 - calling from within 140
 - deleting log items 139
 - logging call manually 139
 - options 138, 161
 - set 137
 - using 137
- call overflow 235
- Call Park 112
 - ATA feature code 196
- Call Pick-up
 - ATA feature code 196
- Call Pickup
 - Directed Pickup 54
- Call Pick-up (Directed)
 - ATA feature code 196
- Call Queuing 105
 - ATA feature code 196
- Call traced 207
- Call Transfer 107
- Call Transfer (ATA feature code) 200
- Call(s) bumped 142
- Callback 113
- Caller ID set 52
- Calling 79
- calls
 - answering calls on CAP 46
 - monitoring with CAP 50
 - using answer key 57
 - using Do Not Disturb 193
- Camp denied 110
- Camp max 110

- Camp to 111
 - Camped 111
 - ~~Camped~~ 244
 - camping calls (see Camp-on)
 - Camp-on 110
 - ATA feature code 196
 - Can't ring again 72, 80
 - CANCEL 237
 - Cancel denied 132
 - CAP
 - answering calls 46
 - monitoring calls 50
 - moving buttons 156
 - prime telephone 46
 - sending messages 128
 - telephone 46
 - CCR (see Custom Call Routing)
 - central answering position
 - sending messages 128
 - telephone 220
 - Centrex
 - 7208 defaults 154
 - centrex template
 - 7316E buttons 151
 - change
 - Hunt Group auxiliary ringer 172
 - Class of Service
 - ATA feature code 196
 - changing 232
 - using a password 229, 231
 - Cleared>LINENAM 132
 - CLID
 - display on busy 51
 - communicating in the office
 - paging 125–128
 - sending messages using display 128
 - Voice Call 133
 - cond pswd, programming 219
 - Conf. on hold 61
 - Conference busy 61
 - Conference Call
 - ATA feature code 197
 - by releasing privacy 68
 - removing yourself from 61
 - using the Conference feature 58
 - contrast adjustment 146
 - control telephone 214, 222
 - Custom Call Routing
 - attendant telephone 85
 - customizing 83
 - language choice 86
 - using 82
 - customizing KIM 49
 - customizing your telephone
 - adjusting ring volume 157
 - Button Inquiry 145
 - changing ring type 157
 - contrast adjustment 146
 - User Preferences 159
- ## D
- date and time
 - changing 27
 - default buttons
 - assignment 150
 - defaults
 - buttons, 7316 150
 - deleting
 - Call Log items 139
 - messages from list 131
 - programmed features 147
 - Denied in admin 243
 - desk pswd 219
 - desktop conferencing 208
 - destination code
 - line for external calls 222

- dial pad
 - entering numbers and letters 32
- dial tone
 - Norstar system 231
 - stuttered 231
- Dial voice call 134
- dialing
 - automatic dial 76
 - direct extension 83
 - options 161
 - pre-dial 77
 - saved number 101
 - standard dial 76
 - switching from pulse to tone 228
- dialing modes 75
- dialing signal
 - Link 224
 - Long Tones 226
 - Pause 225
 - Programmed Release 226
 - run/stop 227
 - switching from pulse to tone 228
 - Wait for Dial Tone 227
- DID
 - 7208 defaults 154
- direct extension dialing, using
 - Custom Call Routing and System Answer 83
- direct inward system access 229
- direct-dial telephone
 - programming 220
- Directed Pickup 54
- directing calls, using Custom Call Routing 82
- DISA (see direct inward system access)
- disconnect
 - from conference 61
 - releasing a call, accidentally 69
 - supervision 233
- Disconnect Supervision 233
- display
 - button equivalents for one-line display 236
 - buttons 19
 - Call information 52
 - changing contrast 146
 - changing the language 146, 162
 - contrast 162
 - display buttons 20
 - one-line 236
 - testing 240
- distinctive ring patterns(DRP)
 - answering a call 44
- distinctive rings 157
- DN (see internal numbers)
- DND 110
- DND transfer 44
- DNs 26
- Do Not Disturb
 - on Busy 38
 - see also DND 193
- Do not disturb 72, 79, 109
- Do Not Disturb on Busy 118
- DRT 45
- E**
- eKIM
 - button programming 49
 - ending a call 50
 - enhanced, answer button 57
 - Enter code 148
 - Enter digits 96, 100
 - Enter zone 127

- entering names and numbers 31
- erasing
 - Call Log items 140
 - messages from list 131
 - programmed features 147
- Evening Sched 216
- Exchanged 156
- Exclusive Hold 78, 104
- Expensive route 72
- extended, answer button 57
- external
 - Call Forward (see Line Redirection)
 - page 125
- external access to Norstar 228
- external autodial
 - programming 95
- external calls
 - line pool 222
- external line
 - routing table 222
- external line buttons 155
- external page option, default
 - page button 154
- external paging equipment 128
- extra-dial telephone 216

F

- F_ 148
- fast busy tone 231
- fax machine, and I-ATA 200—201
- feature
 - Message Reply
 - Enhancement, analog telephones 130
- Feature button 19
- feature button 19
- Feature code 148
- Feature moved 148

- Feature timeout 243
- Features
 - adjusting ring volume 157
 - Autobumping 139
 - autodial 95
 - auxiliary ringer 224
 - Background Music 194
 - Call Display 50
 - Call Duration Timer 69
 - Call Forward 115
 - Call Information 51
 - Call Log 137
 - Call Park 111
 - Call Pickup 54
 - Call Queuing 105
 - Call Transfer 107
 - Callback 113
 - Camp-on 110
 - changing ring type 157
 - Class of Service password 232
 - Conference Calls 58
 - contrast adjustment 146
 - Custom Call Routing 85
 - dialing modes 75
 - dialing signal
 - Link 224
 - Long Tones 226
 - Pause 225
 - Programmed Release 226
 - run/stop 227
 - Wait for Dial Tone 227
 - Do Not Disturb on Busy 118
 - Exclusive Hold 104
 - Handsfree 63
 - hiding the message or calls
 - display 158
 - Hold 103
 - language choice 146

- Last Number Redial 97
 - line pools 73
 - Line Redirection 119–124
 - Messages 128
 - moving line buttons 156
 - paging 125–128
 - priority call 77
 - Privacy 68
 - Restriction service 211
 - Ring Again 79
 - ring type 157
 - Ringing service 211
 - Routing service 211
 - Saved Number Redial 101
 - sending messages using
 - display 128
 - Set Lock 223
 - Speed Dial 99
 - System Answer 84
 - Test a Telephone 239–242
 - Time and Date 217
 - Trunk Answer 56
 - User Preferences 159
 - Voice Call 133
 - Voice Call Deny 134
 - features
 - Button Inquiry 145
 - Do Not Disturb 193
 - Group Listening 62
 - file transfer 208
 - Flash (feature) 224
 - Forward denied 119
 - Forward> 119
 - forwarding calls 35
 - Call Forward 115
 - Call Forward delay 117
 - Call Forward on Busy 117
 - Do Not Disturb on Busy 118
 - Forward no answer 117
 - Line Redirection 119–124
- G**
- Get call first 113
 - greetings, Auto Attendant
 - changing the language 86
 - Custom Call Routing 82
 - customizing 89
 - pre-recorded 89
 - recording 92
 - Group 4 fax 208
 - group answering
 - SWCA keys 105
 - Group Listening 62
 - Group Pickup 54
- H**
- handling many calls at once
 - Call Queuing 105
 - Hold 103
 - handset
 - testing 241
 - handset speaker
 - testing 241
 - Handsfree
 - assign button 66
 - indicators 65
 - making calls 63
 - muting 64
 - Handsfree Answerback
 - programming 67
 - Voice Call 134
 - handsfree button 155
 - Heading 22
 - headset
 - Handsfree requirement 66
 - testing 241
 - hearing aid compatibility 50
 - Hidden number 72, 98, 102
 - Hold

- ATA feature code 197
- button 19
- Conference Call 59
- exclusive 104
- listening while on hold 104
- retrieving call 103
- using SWCA keys 105
- Hold or release 142
- ~~Hold or release~~ 245
- Hospitality 179, 181
- hospitality
 - password 219
- host system signaling
 - Link 224
 - Pause 225
 - Programmed Release 226
 - run/stop 227
 - Wait for Dial Tone 227
- Hotline
 - bypassing 221
 - setting up the telephone 221
- Hunt Groups 36, 38, 39, 41, 55, 57, 77, 79, 81, 103, 112, 116, 117, 118, 126, 133, 165, 194, 221, 233
 - adding or removing members 166
 - Answering incoming calls 41
 - assigning and unassigning lines 168
 - auxiliary ringer 172
 - broadcast conversion note 165
 - Broadcast mode 169
 - moving members 167
 - programming busy line
 - setting 170
 - programming the overflow set 171
 - programming the queue time-out 171
 - Rotary mode 169
 - Sequential mode 169
 - setting the distribution mode 169
 - setting the hunt delay 170
 - setting the name 172
- hunt groups
 - system monitoring 222
- Hybrid
 - 7208 defaults 154
- I**
- I-ATA (see analog terminal adapter, internal 195)
- In use 132
- ~~In use~~ 246
- In use SETNAME 142
- Inactive feature 243
- incoming call
 - CLID display on busy 51
- Incoming Line Groups (ILG), see Hunt Groups
- ~~Incoming only~~ 246
- indicators
 - handsfree and mute 65
 - message waiting, analog telephone 129
- installer programming 16, 25
- integrated services digital network (see ISDN) 203
- Intercom 122
- Intercom # 96
- internal analog terminal adapter (see analog terminal adapter, internal) 195
- internal numbers
 - length of 233
- internal page 125

- Internet access 209
- Invalid code 100, 227
- Invalid code 243
- Invalid location 156
- Invalid number 96, 109, 113
- Invalid number 246
- Invalid Password 232
- Invalid state 207
- Invalid zone 127
- ISDN
 - applications 208–209
 - capacity 203
 - equipment 208–209
 - Internet access 209
- K**
- KIM
 - buttons on eKIM 49
 - customizing 49
 - using 46
- L**
- LAN access 208
- LAN bridge 208
- LAN router 208
- language
 - changing on the display 146, 162
 - choice for Auto Attendant 86
- Last Number Redial
 - programming 98
- Last Number Redial (ATA feature code) 198
- Last Number Redial, using 97
- leased line backup 208
- length of call, timing 69
- length of internal numbers 233
- letters, entering with dial pad 32
- limiting
 - access to Norstar 229
 - telephone feature use 223
 - telephone programming 223
 - using alternate or scheduled services 211
- line
 - changing the name 34
 - target 234
- Line 001 waiting 244
- line appearances
 - using SWCA keys 105
- line assignment 234
- line button
 - moving 42, 156
 - using to choose a line 73
- Line denied 56, 72
- Line denied 246
- Line hung up 111
- Line in use 245
- line indicators
 - description 42
- line pool 73–75, 235
 - external lines routing 222
- line pool access code
 - external calls 222
- line pool and ATA 198
- Line Redirection 119–124
- Line Redirection 122
- Line Redirection and Call Forward, differences 123
- line, changing the name 192
- Line001 callback 45
- Line001 hung up 109
- Line001 to prime 45
- Line001 transfer 244
- Link
 - ATA feature code 198
 - using 224
- Link, programming 225
- LIST 160

- listening on hold 104
- log space
 - programming 142
- logging a call manually 139
- Logit (see Call Log)
- long distance call
 - indicator 243
- long distance calls, using COS
 - password 228
- Long Tones 226
- Long Tones 226
- Lunch Sched 216
- M**
- maintaining security 230
- Make calls first 246
- making calls
 - dialing modes 75
 - priority call 77
 - using a line button 73
 - using line pools 73
 - using Ring Again 79
 - with automatic Handsfree 66
- memory buttons 19, 95, 236
 - default assignment 150
- Message denied 132
- Message list 132
- Message Reply Enhancement 130
- Message to 132
- message waiting indicator,
 - analog telephone 129
- Messages
 - ATA feature code 198
 - cancelling a sent message 129
 - hiding display 158
 - removing from list 131
 - sending 128
 - sending using the display 128
 - viewing 129
- messages
 - analog telephone, answer 129
- Messages & Calls 132, 143
- Microphone muted 134
- modem, and I-ATA 200–201
- monitoring
 - answer DNs and answer key 57
 - calls 234
 - calls with CAP 50
 - line pool status 79
 - lines (see also Disconnect Supervision) 233
 - telephone status 79
 - transferred calls 113
- Move line from 156
- Move line to 156
- moving
 - telephones 192
- music, background 194
- mute
 - assign button 66
 - button positioning on sets 155
 - indicators 65
- muting voice call tones 133
- N**
- names
 - spelling out 31
- Network Call Diversion 207
- New calls begin 143
- Next 22
- night control phone (see control telephone)
- Night Sched 216

Night Service (see Services)

9_ 71

9_ 246

No button free 132

No button free 245

No call on 113

No calls waiting 244

No free lines 246

No info to log 143

No last number 72, 98

No line selected 72

No line selected 244, 246

No line to use 122

No log assigned 143

No number saved 102

No number stored 100, 133

No response 207

No resume item 143

No services ON 215

No voice call 135

Norstar system dial tone 231

Not allowed 207

Not available 207, 243

Not in service 72, 109, 111, 119

Not in service 244

Not incoming 207

Not subscribed 207

numbers, entering with dial pad
32

O

OK 237

On another call 72, 79

On hold 104

one button access to features 50

one button dialing (see Autodial)

Outgoing line 122

overflow call routing 235

overlay 20

positioning on the set 21

OVERRIDE 237

overriding

Call Forward 116

P

page

ATA feature code 198

default button 154

external equipment 128

programming 126

shortcut codes 125

types 125

zones, programming 126

Page choice 127

Page timeout 127

Paging ALL 127

Paging busy 127

Park denied 113

Parked call 244

Parked on 113

parking a call

retrieving 111

Parking full 113

password 179

Basic 159, 217

Call Log 141

changing 217

Class of Service 231

clearing Call Log 218

cond pswd 219

desk pswd 219

Hospitality password 219

System Coordinator 217

User Preferences 159

Pause 225

ATA feature code 198

pause in a sequence of numbers
(see Wait for Dial Tone)



PBX

- 7208 defaults 154
- PBX template
 - 7316E buttons 151
- personal programming 16
- Pick up receiver 245
- Pickup 56
- Pickup denied 55, 56
- Please wait 78
- Pool code 122
- positioning the overlays 21
- power supply
 - testing 242
- pre-dial 77
- Press a button 97, 145, 148
- Press a line 156
- Press held line 61
- prime line 222, 237
 - external call routing 222
- prime telephone 44
 - CAP 46
- priority call
 - ATA feature code 199
- priority call (see also Call Queuing) 77
- Priority denied 78
- Priority>223 245
- Privacy
 - ATA feature code 199
 - changing status 68
- private branch exchange,
 - accessing from Norstar (see also host system dialing signals) 224
- private call 68
- private line 237
- Program and HOLD 97, 100, 148
- Program and OK 97, 100, 148
- Programmed 97
- Programmed Release 226
- programming 181
 - hospitality cond password 219
 - hospitality desk password 219
 - hospitality password 219
 - KIM 49
 - programming overlay 20
 - system features
 - Call Forward 35, 38
 - changing the name of a line 34
 - changing the name of a telephone 32
 - System Speed Dial 29
 - time and date 27
 - telephones
 - Call Forward 35, 38
 - changing number of rings before forwarding call 36
 - changing the name of a telephone 32
 - Do Not Disturb 193
 - Do Not Disturb on Busy 38
- programming basics
 - administration programming 16
 - Basic password 16
 - customizing your Norstar 16
 - entering passwords 25
 - installer programming 16
 - personal programming 16
 - programming indicator 22
 - programming map 22, 23–25
 - recording changes 15

- starting and ending a session 25
 - understanding programming 15
 - programming lines
 - changing the name of a line 192
 - programming system features
 - adding or removing telephones from Custom Call Routing groups 88
 - attendant telephone 85
 - changing the language used by System Answer and Custom Call Routing 86
 - changing the number of rings for Custom Call Routing 87
 - changing the number of rings for System Answer 87
 - Restriction service 211, 212
 - Ring service 211
 - Routing service 211
 - System Speed Dial 99
 - programming telephones
 - allowing Line Redirection 121
 - auxiliary ringer 224
 - Call Display 53
 - Call Forward delay 117
 - Call Pickup 54
 - changing the name of a telephone 192
 - direct-dial telephones 220
 - external autodial button 95
 - Forward no answer 117
 - Forward on busy 117
 - Handsfree 66
 - HF Answerback 67
 - Hotline 221
 - Last Number Redial 98
 - Link 225
 - page zone 126
 - paging 126
 - priority call 77
 - Redirect ring 121
 - Saved Number Redial 102
 - Set lock 223
 - User Speed Dial 99
- Q**
- QUIT 237
- R**
- recording programming 15
 - redialing
 - external number 97
 - Redir by 122
 - Redirect ring
 - programming 121
 - Redirect½denied 122
 - redirection loops 124
 - refusing to answer second call 193
 - Release a call 111
 - Release a call 245
 - Release button 19, 50
 - icons 19
 - Release calls 245
 - releasing
 - from conference 61
 - releasing a call
 - accidentally 69
 - remote access 228–230
 - remote use
 - Class of Service password 231
 - security 229

- using lines and features
 - from outside the system
- 228
- remove
 - message, analog telephone
- 131
- replying to a message 130
 - analog telephone 130
- reporting and recording alarms
- 239
- Restr'n 215
- Restricted call 72, 109
- ~~Restricted call~~ 246
- restricting
 - access to Norstar 229
 - feature use (see Set Lock)
 - telephone feature use 223
 - telephone programming 223
 - using alternate or scheduled services 211
- Restriction service 211
- retrieval codes
 - Call Park 112
- retrieving
 - held call 103
 - parked call 111
- ring
 - auxiliary ringer 224
 - changing ring type 157, 162
 - changing the number of rings before call is
 - forwarded 36
 - description of types 43, 157
 - ring volume 157
 - Ringling service 213
- Ring Again 79
- Ring Again (ATA feature code)
- 199
- Ring Again? 73, 80
- Ringling 215
- ringling
 - distinctive ring patterns 44
- Ringling service 211
- RLS button 50
- Routing 215
- routing
 - external lines 222
- routing calls, using Custom Call
- Routing 82
- Routing service 211
- run/stop signal 227
- S**
- Saved Number Redial
 - using 101
- Saved Number Redial, programming 102
- saving a number (see Saved Number redial)
- Sched 4 216
- Sched 5 216
- Sched 6 216
- scheduled services 211
- security
 - recommendations 230
 - system 229
- Select a line 73, 100
- Select line out 122
- Select line(s) 122, 123
- Send message? 73
- Service Modes (see Services)
- Service Modes ON 216
- Service Schedules
 - Evening Sched 216
 - Lunch Sched 216
 - Night Sched 216
 - Sched 4 216
 - Sched 5 216

- Sched 6 216
 - Services
 - overriding 216
 - Restriction service 211
 - Ringinɡ service 211
 - Routing service 211
 - Trunk Answer 56
 - turning off and on using feature codes 213
 - viewing active schedules 214
 - Set Lock 223
 - Set, locked 243
 - SHOW 237
 - Show 22
 - signal
 - Link 224
 - Long Tones 226
 - Pause 225
 - Programmed Release 226
 - run/stop 227
 - Wait for Dial Tone 227
 - special telephones 220
 - Speed Dial
 - adding or changing 29
 - changing User Speed Dial 161
 - choosing a system code 30
 - choosing the display 31
 - host system signaling codes 99
 - making a call 99
 - programming 29
 - programming User 99
 - selecting a line 30
 - splitting a Conference Call 60
 - square template
 - 7316E buttons 151
 - standard dial 76
 - Start of list 133
 - Still in trnsfer 109
 - stop calls from ringinɡ at set 193
 - stuttered dial tone 231
 - suspending a call (see also Call Park and Hold)
 - SWCA
 - using 105
 - System Answer 81
 - attendant telephone 85
 - customizing 83
 - language choice 86
 - system dial tone 231
 - system monitor telephone
 - using 222
 - System Speed Dial 99
 - System Speed Dial (ATA feature code) 199
- T**
- target line 234
 - changing the name 192
 - telecommuting 208
 - telephone
 - 7316E and KIM 46
 - adjusting the display
 - contrast 146
 - alarm 239
 - answer message on analog telephone 129
 - attendant 85
 - button inquiry 145
 - Call Display information 52
 - central answering position 220
 - changing the name 192
 - control 214, 222
 - default button assingment 150
 - direct-dial 220

- extra-dial 213, 216, 220
- Feature button 19
- Hold button 19
- Hotline 221
- log calls automatically 137
- moving 192
- prime 220
- prime telephone 44
- Release button 19
- stop ringing using DND 193
- system monitor, hunt groups 222
- testing 239–242
- volume control 19
- template, button assignments 150
- testing
 - buttons 239, 240
 - Custom Call Routing 94
 - display 240
 - ending a session 240
 - handset 241
 - headset 241
 - power supply 242
 - System Answer 94
 - telephone 239
 - telephone speaker 241
- Their list full 133
- 3 parties only 61
- time and date
 - **8463 217
 -  * * T I M E 27
 -  806 132
 - changing 27
 - displayed instead of
 - messages and calls 158
 - length of a call 69
- time savers
 - autodial 95
 - Saved Number Redial 101
 - Speed Dial 99
- Timed Release
 - ATA feature code 199, 200
- tone
 - camped call tones 110
 - controlling length 226
 - remote access tones 231
 - voice call 133
- Tones (ATA feature code) 200
- tracking incoming calls
 - Call Log 137
- transfer (see Call Transfer)
- Transfer denied 110
- transferring calls 107
 - Callback 113
 - Custom Call Routing 82
 - parking a call 111
 - using Camp-on 110
- transmission rates, with internal analog terminal adapter 201
- troubleshooting
 - internal analog terminal adapter 201
 - reporting and recording alarms 239
 - testing the headset 241
 - testing the power supply 242
 - testing the speaker in the handset 241
 - testing the telephone
 - buttons 240
 - testing the telephone display 240
 - testing the telephone speaker 241
 - using the alarm telephone 239
- Trunk Answer 56

ATA feature code 200

U

understanding programming 15

Unequipped line 122

Unknown name 142

Unknown number 100

until * 215

UPDATE 26

Use line pool? 245

User Preferences 159–163

 * * U S E R 217

User Speed Dial 99, 161

using DND 193

using Norstar remotely 228–230

using this guide 15

V

videoconferencing 208

VIEW 237

viewing

 active Services 214

 Call Log 139

 messages 129, 132

Voice Call 133–134

Voice call 134

voice mail

 accessing your Norstar system 143

 using Call Forward 119

volume

 bar 237

 control 237

W

Wait for Dial Tone 227

wall mounting

 BST sets 190

Y

Your list full 133

